



United States Department of the Interior

BUREAU OF LAND MANAGEMENT

Carson City Office
5665 Morgan Mill Rd.
Carson City, Nevada 89701-1448
<http://www.nv.blm.gov/Carson>



In Reply Refer to:
4400 (NV-032)

April 2, 2008

Dear Interested Party:

Enclosed is a copy of the Churchill Canyon Allotment Evaluation. Please review the enclosed document and provide written comments before April 18, 2008.

Please mail comments to: Bureau of Land Management
Carson City Field Office
Attn: Katrina Leavitt
5665 Morgan Mill Road
Carson City, NV 89701

Comments may also be faxed to: (775) 885-6147

Before including your address, phone number, e-mail address or other personal identifying information in your comment, you should be aware that your entire comment, including your personal identifying information, may be made publicly available at any time. While you can ask us in your comment to withhold your personal identifying information from public review, we can not guarantee that we will be able to do so.

If you have any questions, regarding the Churchill Canyon Allotment Evaluation please contact Katrina Leavitt at (775) 885-6130.

Sincerely,

Katrina Leavitt
Rangeland Ecologist

Enclosure: Churchill Canyon Allotment Evaluation

RECEIVED

APR 07 2008

DEPARTMENT OF ADMINISTRATION
OFFICE OF THE DIRECTOR
BUDGET AND PLANNING DIVISION

United States Department of the Interior

BUREAU OF LAND MANAGEMENT

**Carson City Field Office
5665 Morgan Mill Road
Carson City, Nevada 89701
<http://www.nv.blm.gov>**

**CHURCHILL CANYON
ALLOTMENT EVALUATION**

April 2008

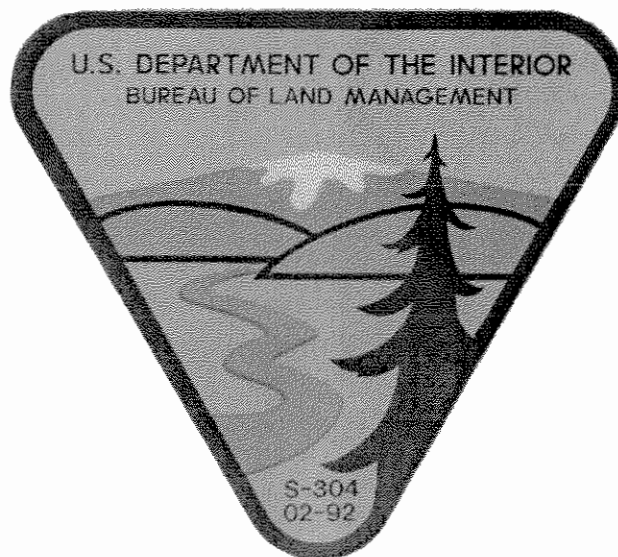

Table of Contents

I.	<u>Introduction</u>	<u>Pages 1-2</u>
	A. Introduction	
	B. Purpose and Need	
	C. Allotment Name and Number	
	D. Permittee	
	E. Evaluation Period	
	F. Selective Management Category	
II.	<u>Initial Stocking Rate</u>	<u>Pages 3-5</u>
	A. Current Permitted Livestock Use	
	B. Historic and Current Livestock Operations	
	C. Wild Horse Use	
III.	<u>Allotment Profile</u>	<u>Pages 6-11</u>
	A. Description	
	B. Acreage	
	C. Natural Resource Objectives	
	D. Key Species	
IV.	<u>Management Evaluation</u>	<u>Pages 12-19</u>
	A. Actual Use	
	B. Precipitation	
	C. Livestock Utilization	
	D. Trend	
	E. Rangeland Health	
	F. General Wildlife Habitat	
	G. Special Status Species	
	H. Riparian Habitat	
V.	<u>Conclusions</u>	<u>Pages 19-21</u>
VI.	<u>Technical Recommendations</u>	<u>Pages 21-22</u>
VII.	<u>Appendices</u>	<u>Pages 23-47</u>
	Appendix I. Key Area Frequency Data	
	Appendix II. Photo Trend Plots	
	Appendix III. Como Burn - Monitoring Data	
	Appendix IV. Rangeland Health Assessments	
	Appendix V. BLM Sensitive Species	
	Appendix VI. Neo-tropical Migratory Birds, Species of Continental Importance	
	Appendix IIX. Riparian Assessments	
	Appendix IX. Summary of Precipitation Data	
	Appendix X. U.S. Drought Monitor	
	Appendix XI. Livestock Utilization within the Churchill Canyon Allotment	

I. Introduction

A. Introduction

The Churchill Canyon Grazing Allotment is located approximately twenty miles southeast of Carson City, Nevada, and is within the Jurisdictional Boundary of the Carson City Field Office (CCFO) of the Bureau of Land Management (BLM). The grazing Allotment is located in Lyon and Douglas Counties and encompass approximately 47,826 acres (Map on Page 2) of BLM managed land. The BLM is currently considering the renewal of the term livestock grazing permit for this Allotment, which includes reviewing the stocking rate and season of use for cattle. This evaluation document summarizes monitoring data that has been collected and provides technical recommendations for future management. The evaluation process provides an opportunity for public review and comment. Information from this evaluation document and process will be utilized to prepare management alternatives which will be analyzed in an Environmental Assessment (EA) prior to the issuance of a new term livestock grazing permit.

B. Purpose and Need

The purpose of the allotment evaluation process is to determine if grazing practices are consistent with the attainment of objectives found in the Carson City Field Office (CCFO) Consolidated Resource Management Plan (CRMP) and other applicable management plans, and implement livestock grazing practices that will ensure compliance with the approved Standards for Rangeland Health & Guidelines for Grazing Management (S&Gs), Sierra Front Northwestern Great Basin Area. Future management of livestock grazing will come through the issuance of a grazing permit which will provide the parameters and guidelines for management of the range resources on the Allotment. An evaluation was needed at this time because, the condition of natural resources on the Allotment was evaluated in 2007 and the current grazing permit will expire in 2008.

C. Allotment Name and Number: Churchill Canyon #3518

D. Permittee: Richard Huntsberger

E. Evaluation Period

Because cattle grazing was permitted on the allotment between 1992 and 2007 those years will be emphasized in this evaluation. However some data prior to 1992 is presented to show historic livestock grazing and trends in plant communities and precipitation cycles.

F. Selective Management Category: I - Improve

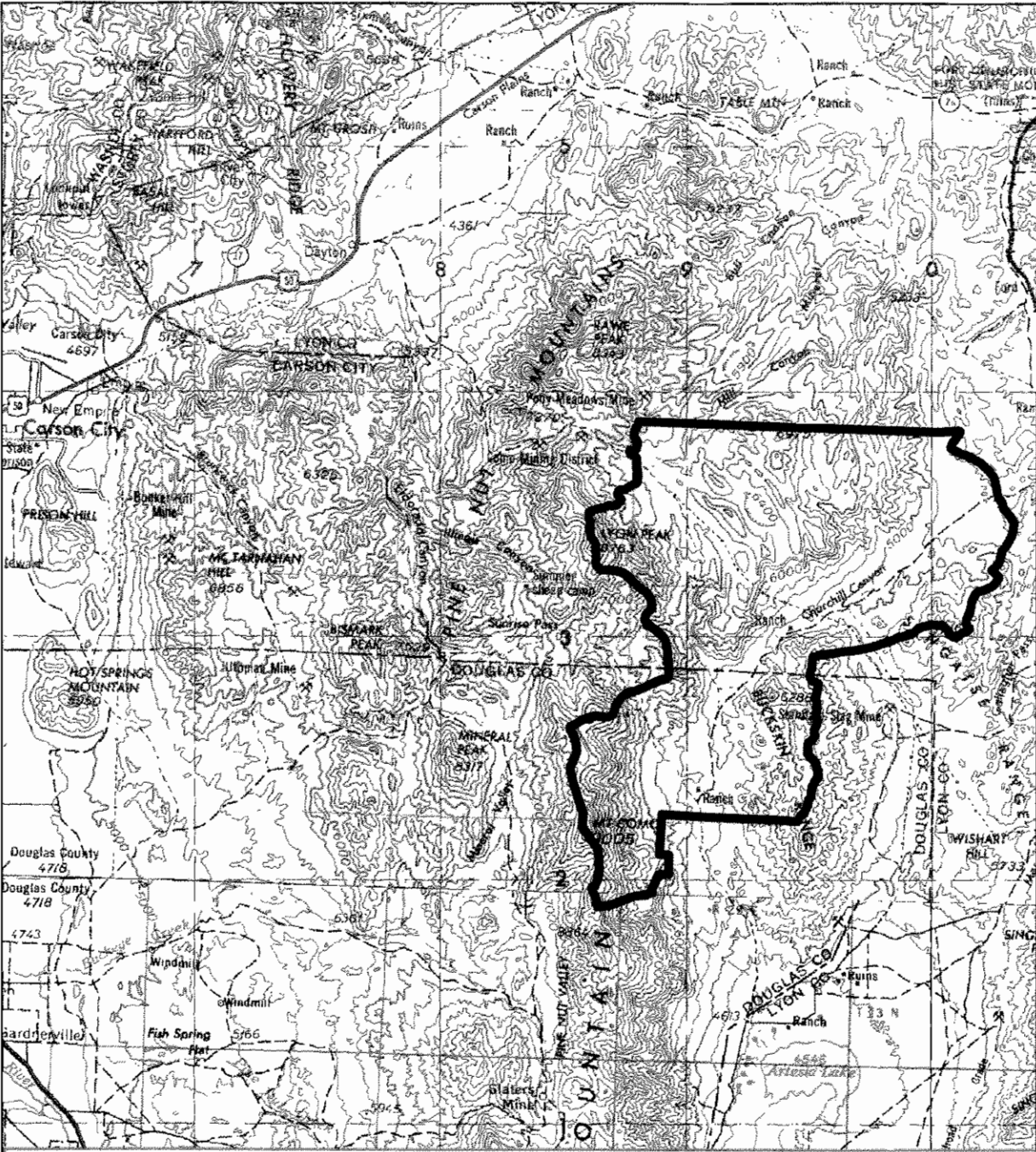

Legend

 Churchill Canyon Allotment



United States Department of the Interior
 Bureau of Land Management (BLM)
 Carson City Field Office
 5665 Morgan Mill Road
 Carson City, NV 89701

No warranty is made by the BLM as to the accuracy, reliability or completeness of these data for individual or aggregate use with other data. 01/08/2008

II. Initial Stocking Rate

D. Current Permitted Livestock Use

The permitted use within the Churchill Canyon Allotment is 166 cattle during the period 11/01-05/15 for a total of 1074 Animal Unit Months (AUMs). The percent federal range within the allotment is 100% and 1074 is the full active grazing preference.

However, actual livestock use has differed from permitted use. The livestock use period has typically been extended until May 31st. In an effort to evaluate a higher stocking rate, stocking has also exceeded 1074 AUMs. These deviations from the grazing permit are documented in the actual livestock use section of this evaluation on page 12.

E. Historic and Current Livestock Operations

The area of land which has become the Churchill Canyon Allotment was utilized for sheep grazing prior to 1992. In 1992 the class of livestock on the Churchill Canyon Allotment was converted from sheep to cattle. The Record of Decision making this conversion stated that the Proposed Action in this case (which was a straight conversion of AUMs from sheep to cattle) would damage the resource. The AUM numbers at that time were in excess of 5,000. An alternative was selected which set the initial stocking rate at 1074 AUM's. It was also decided that a three year permit should be issued due to a lack of monitoring data and first hand experience with how cows would behave on this particular allotment. A permit was issued for a period of three and a half years.

In September of 1993, Richard Huntsberger acquired the Churchill Canyon Allotment. An allotment evaluation was performed on the allotment during the 1993-1994 grazing season. Average utilization across the allotment was 55%, which is classified as a high moderate level. The Pine Nut Final Multiple Use Decision (FMUD) was signed the following year (08/18/95). This decision maintained the stocking rate at 1074 AUM's, calling this level "reasonable". The decision also said BLM would obtain further data to refine the estimate and establish a preference which is sustainable.

A subsequent grazing permit was issued to Mr. Huntsberger in 1997 for a one year period. The permit stated that an analysis would be made following the 1998 grazing season and preference would be adjusted based on that analysis.

A new 10 year grazing permit was issued in 1998 which maintained the stocking rate at 1074 AUM's. This permit is still in effect at the current time.



Mr. Huntsberger has maintained the position that he should receive an increase in permitted AUM's over the original 1074 allocated during the conversion in 1992. In response to a formal request for an increased stocking rate in 1998, an EA was prepared in 2000 (EA-NV-030-00-013). The EA found that that data collected prior to that time suggested there might be additional AUM's on the allotment and proposed the following course of action for future management. A final decision issued in 2003 (06-30-03), implemented the following elements of the Proposed Action described in the EA. Maintain the permitted stocking rate at 1074 AUM's and provide for the possibility of a temporary increase in stocking rate up to a

maximum of 883 additional AUM's each year, for the next five grazing seasons, based on certain requirements. These requirements are that the excess forage (over and above 1074 AUM's) must be verified by BLM range specialists each year that temporary non-renewable (TNR) use is applied for, and range condition on the allotment must be such that additional grazing will not cause a deterioration in such condition. The excess forage so verified must be in locations that the permittee has demonstrated are usable by his livestock under conditions existing on the allotment at that time. The construction of specific range improvements were authorized along with a rotational grazing system and a fifteen day extension of the grazing season. The use of additional AUM's was authorized between 2003-2007.



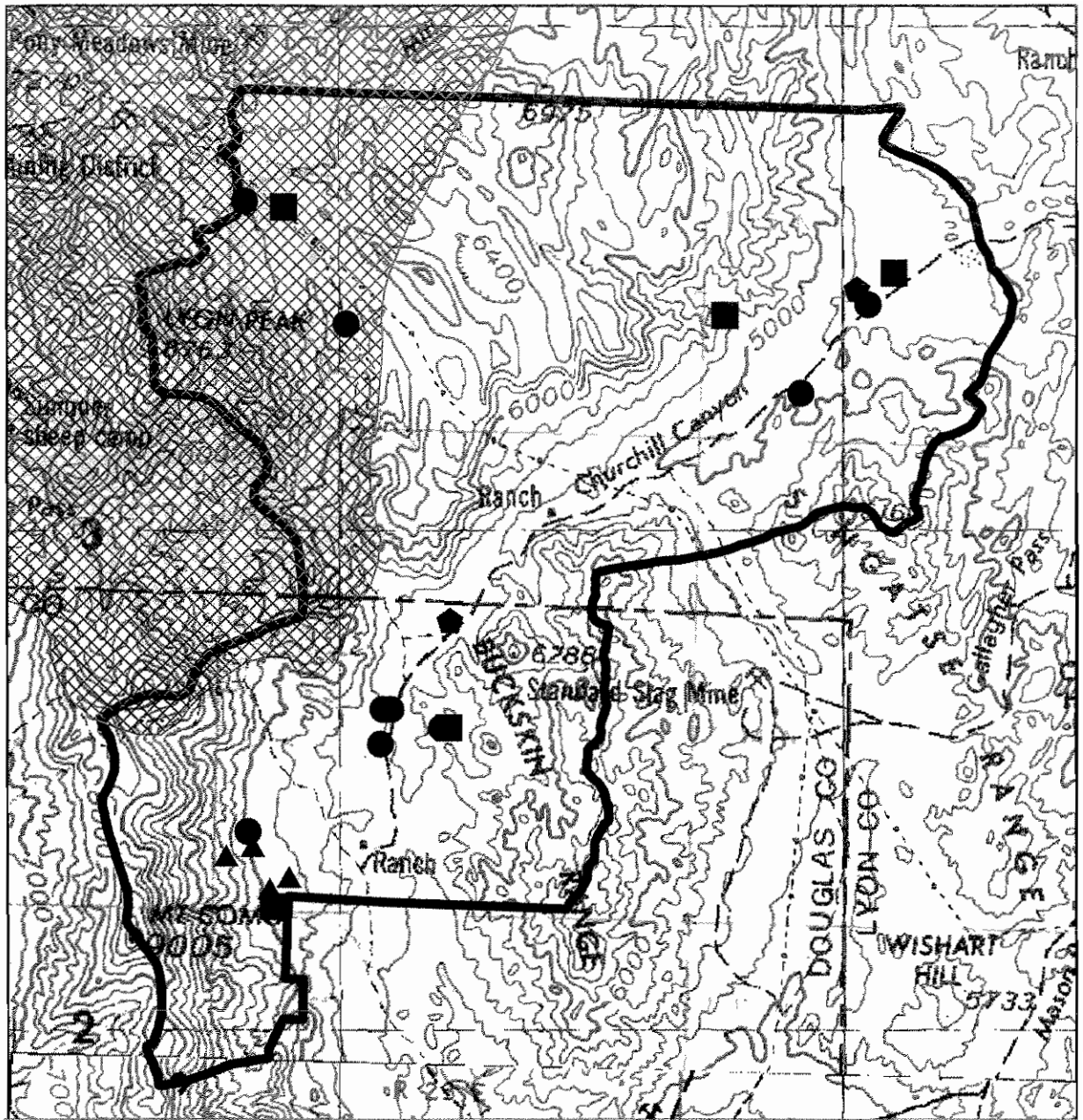

F. Wild Horse Use

The northwest section of the Churchill Canyon allotment (8,500 acres) is within the Northern Pine Nut Wild Horse Herd Management Area (HMA). Please reference the HMA map on page 5. The stocking level for wild horses in the allotment was determined to be 154 AUMs, or 12 horses year round (Pine Nut Final Multiple Use Decision 08/18/95). Use by wild horses has been continuous since at least the early 1970s with most occurring in areas outside of the Churchill Canyon Area. Census information compiled in 1995 documents a high of 100-150 head within 7 miles of Churchill Canyon and a low of 15 in 2002. Numerous gathers, both large and small, have removed approximately 750 head from the entire HMA over the last 12 years. Of the total, two large gathers were completed with 410 removed in 1995 and 232 removed in 2003. A post gather census following the 2003 removal documented 19 head in the area within 5 miles of Churchill Canyon. Since 2003 a total of 26 horses have been removed because of private property issues. The current estimated population for the entire HMA is 146.



- Legend**
-  Churchill Canyon Allotment
 -  Pine Nut Herd Management Area

Monitoring Locations

-  Fire Rehabilitation Monitoring
-  Frequency Transect
-  Photo Trend Plot
-  Rangeland Health

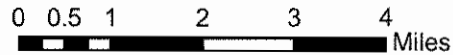
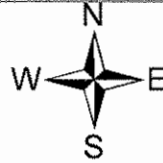

United States Department of the Interior
 Bureau of Land Management (BLM)
 Carson City Field Office
 5665 Morgan Mill Road
 Carson City, NV 89701

No warranty is made by the BLM as to the accuracy, reliability or completeness of these data for individual or aggregate use with other data. 01/08/2008

III. Allotment Profile

E. Description

The Churchill Canyon Allotment can be split into three general management areas. The northeast portion of the allotment also known as the Sario Well Pasture is at the lowest elevation. The average elevation is around 5000 feet. The plant communities present within this portion of the allotment are: 1) low sagebrush, bottlebrush squirreltail, Douglas rabbitbrush; 2) Shadscale, Bailey greasewood, Indian ricegrass, bud sagebrush; and 3) basin big sagebrush, green ephedra, spiny hopsage, bottlebrush squirreltail. The main water sources include three wells in the bottom of the Churchill Canyon drainage. There are drift fences along the northern, eastern and southern allotment boundaries. There is also a drift fence in Churchill Canyon which separates this portion of the allotment from the southern portion of the allotment. This portion of the allotment was affected by a fire in 2007. There is a map on page 8 to accompany this description of the pasture.

The southern portion of the allotment also known as the JW Ranch pasture, contains the mid elevation pastures for the allotment. The average elevation is around 6000 feet. The plant communities present within this portion of the allotment include 1) low sagebrush and needlegrass on the western slopes of the Buckskin range; 2) Wyoming big sagebrush and Anderson peachbrush in the valley bottom along the Churchill Canyon road; and 3) post fire plant communities on the eastern slope of the Pine Nut Mountains. Throughout the burned areas there is an abundance of annual species such as cheatgrass and mustard. From the mountain ridge approximately a third of the way down slope the dominant perennial plants are bluegrass species. From approximately a third of the way down slope to two thirds of the way down slope where the alluvial fan begins the density of perennial vegetation is low and appears to consist of grasses which survived the fire. The types of species present include needlegrasses, Mountain brome, Indian ricegrass, bottlebrush squirreltail and basin wildrye. In the sunrise burn to the north there are mature rabbitbrush and bitterbrush plants and sagebrush seedlings. On the alluvial fan the dominant perennial vegetation consists of low densities of desert peachbrush, horsebrush, sagebrush, fourwing saltbrush, rabbitbrush, needlegrass and squirreltail. The exception is a very dense stand of desert peachbrush at the base of the Sunrise burn along the main Churchill Canyon road. Main water sources in this portion of the allotment consist of several springs and meadows. There are drift fences along the northern and southern allotment boundaries. This portion of the allotment is also cross fenced which divides the area into five separate management units, upper spring gulch, como burn, sunrise burn, big meadow and the buckskins (Map on Page 9).

The northwest portion of the allotment also known as the Como Pasture is at the highest elevation. The average elevation is around 6500 feet. The plant communities present within this portion of the allotment are: 1) low sagebrush, bottlebrush squirreltail and singleleaf pinyon; 2) pinyon, Wyoming big sagebrush, antelope bitterbrush, green rabbitbrush; and 3) pinyon, juniper, mountain big sagebrush and antelope bitterbrush. The main water sources include winter accumulation of precipitation in three dry lake plays and one dugout pond. There is also a small spring (Mud Spring). With the exception of a small drift fence on the back country byway road there is no fencing within this portion of the allotment (Map on Page 10).

F. Acreage

The Churchill Canyon Allotment is approximately 47,866 acres in size and approximately eight percent of the allotment is within the Pine Nut Wildhorse Herd Management Area (HMA). Forty acres are privately owned and the remainder is managed by the BLM. Three wildfires have occurred within the allotment. In July of 1996 the Sunrise fire burned 2,957 acres within the allotment. The Como Fire burned an additional 1,744 acres in October 2000. The most recent fire was the Adrian Fire which burned 3,395 acres in July 2007. The HMA map is on page 5 and the map of recent fires history is on page 11.

G. Natural Resource Objectives

- 1) Maintain or improve the condition of the public rangelands to enhance productivity for all rangeland and watershed values.
- 2) Maintain a sufficient quality and diversity of habitat and forage for livestock, wildlife, and wild horses through natural regeneration and or vegetation manipulation methods.
- 3) Improve the vegetation resource and range condition by providing for the physiological needs of key plant species.
- 4) Reduce soil erosion and enhance watershed values by increasing ground cover and litter.
- 5) Improve riparian-wetland ecosystems to achieve a healthy proper functioning condition that assures biological diversity, productivity and sustainability.
- 6) Manage wildlife habitat for a long-term goal of providing forage for reasonable numbers of big game.
- 7) Maintain and improve wildlife habitat, including riparian/stream habitats, and reduce habitat conflicts while providing for other appropriate resource uses.
- 8) Maintain or improve the habitat condition of meadow and aquatic areas. Habitat condition for any wildlife species can be defined as the ability of a specific area to supply the forage, cover water and space requirements of an animal. Habitat condition, therefore is a measure of habitat quality and is determined by assessments surveys and studies.
- 9) In order to provide forage for over-wintering mule deer, allow no more than 25% use on bitterbrush by livestock and wild horses in the deer winter range before October. Yearlong use by all herbivores should not exceed 45%.
- 10) Improve sagegrouse habitat by making progress toward meeting the goals and objectives identified in the Nevada Governor's Sage Grouse Conservation Plan.

H. Key Species

Plant species that are selected for monitoring are called key species. Some of the factors that are considered when selecting key species include selecting species that are abundant, species that are important to wildlife, species that are critical to the attainment of specific management goals, and species that are palatable to livestock, wildlife or wild horses. Herbivores graze selectively, and can under certain grazing conditions suppress favored species of plants and bolster competitors that are less desirable as food.

Key species in the Churchill Canyon Allotment include, Indian ricegrass (*Achnatherum hymenoides*), two species of needlegrass (*Achnatherum speciosum* & *thurberianum*.), winterfat (*Krascheninnikovia lanata*), and Bitterbrush (*Purshia tridentata*).

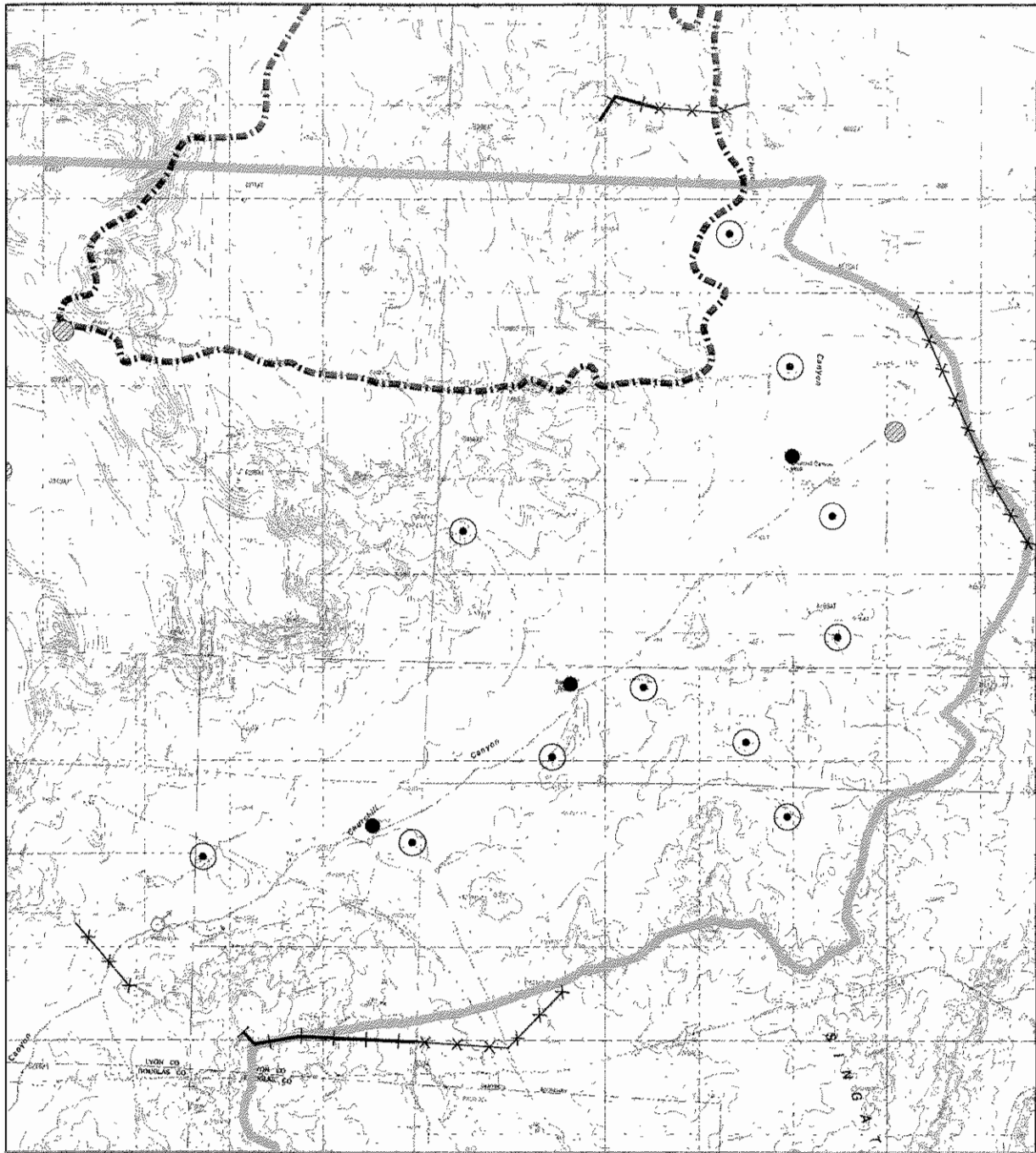

Legend

- Meadow
- Spring
- Water Hole
- Water Haul or Salt
- Well
- Existing Fence
- Proposed Fence

Sario Well Pasture

Churchill Canyon Allotment

Adrian Fire 2007

0 0.5 1 Miles

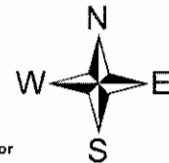

United States Department of the Interior
 Bureau of Land Management (BLM)
 Carson City Field Office
 5665 Morgan Mill Road
 Carson City, NV 89701

No warranty is made by the BLM as to the accuracy, reliability or completeness of these data for individual or aggregate use with other data. 01/08/2008

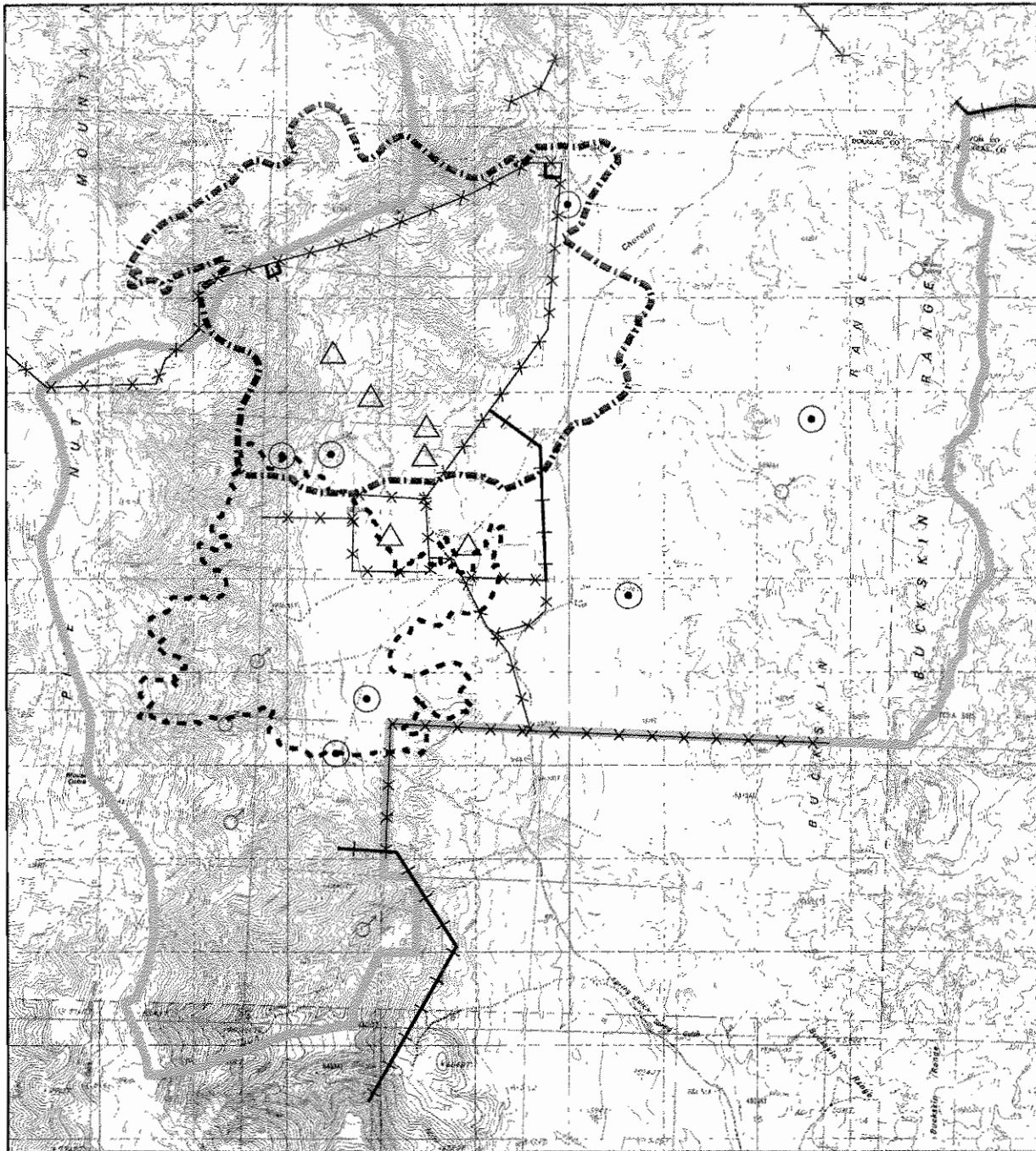



Legend

- △ Meadow
- Spring
- ⊗ Water Hole
- ⊙ Water Haul or Salt
- Well
- × Existing Fence
- Proposed Fence

JW Ranch Pasture

 Churchill Canyon Allotment

 Sunrise Fire 1996

 Como Fire 2000

0 0.5 1 Miles

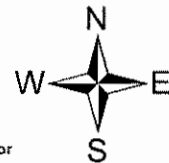
United States Department of the Interior
 Bureau of Land Management (BLM)
 Carson City Field Office
 5665 Morgan Mill Road
 Carson City, NV 89701

No warranty is made by the BLM as to the accuracy, reliability or completeness of these data for individual or aggregate use with other data. 01/08/2008

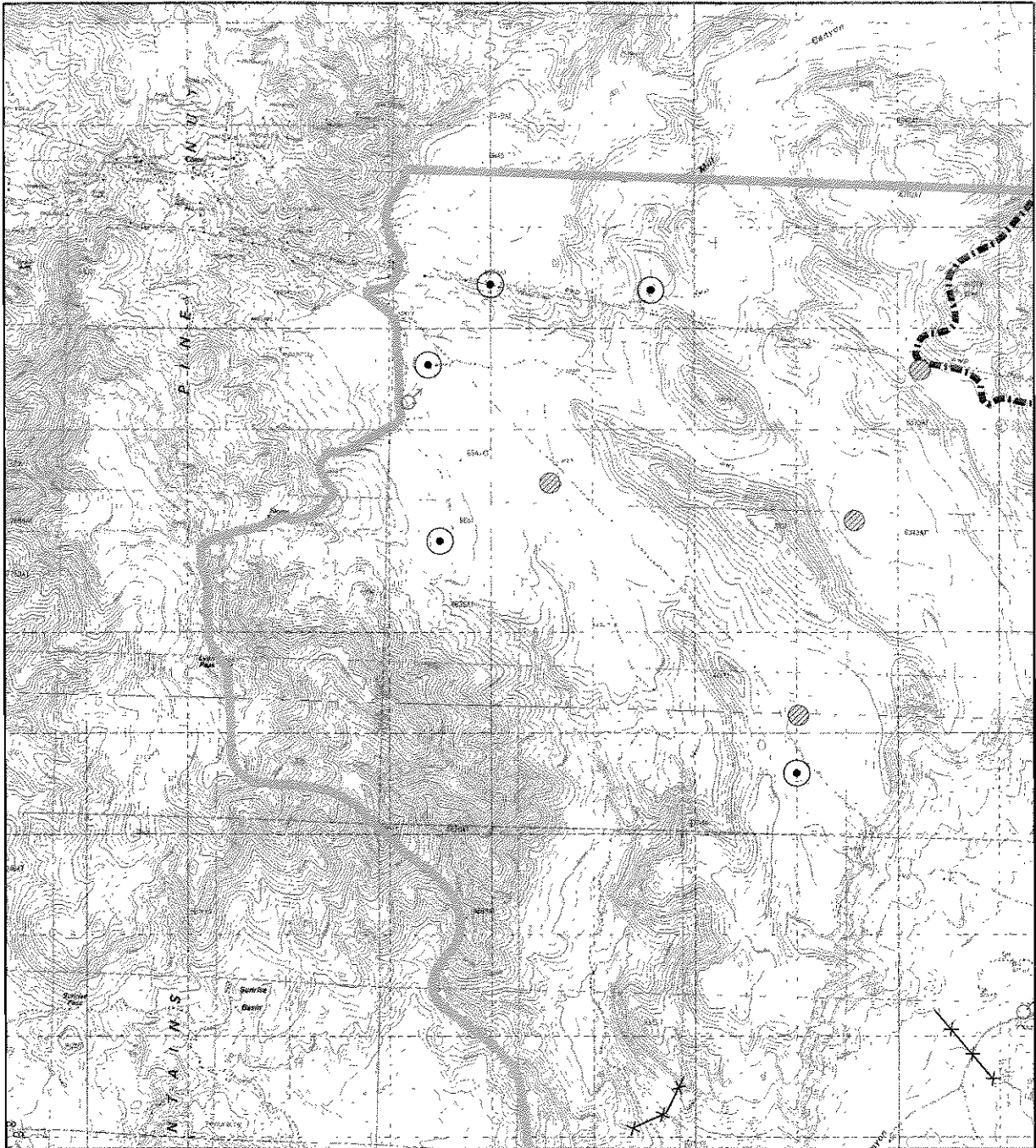

Legend

- △ Meadow
- ♂ Spring
- ⊗ Water Hole
- ⊙ Water Haul or Salt
- Well
- × Existing Fence
- Proposed Fence

Como Pasture

Churchill Canyon Allotment

Adrian Fire 2007

0 0.5 1
Miles

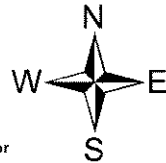

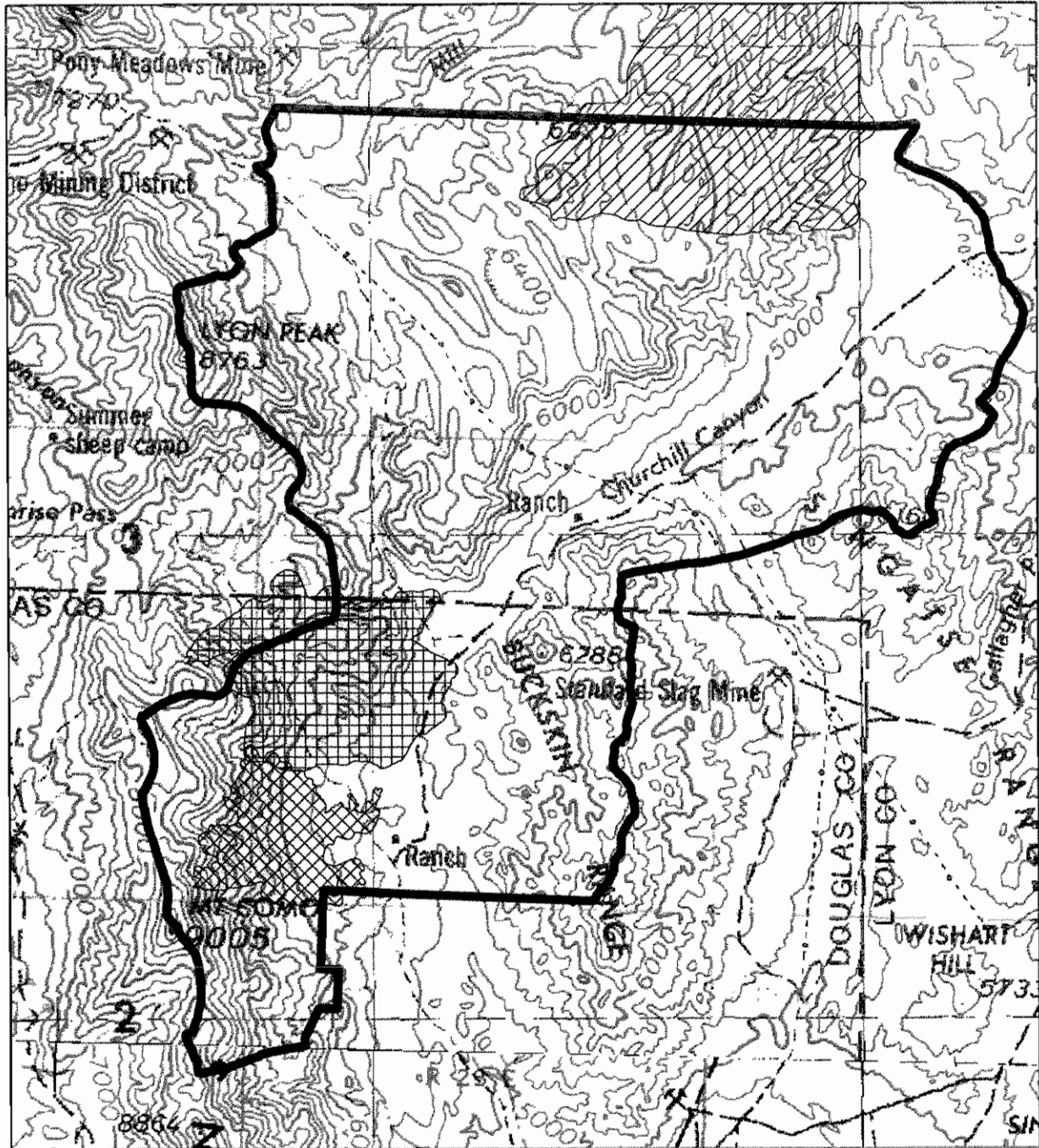

United States Department of the Interior
Bureau of Land Management (BLM)
Carson City Field Office
5665 Morgan Mill Road
Carson City, NV 89701

No warranty is made by the BLM as to the accuracy, reliability or completeness of these data for individual or aggregate use with other data. 01/08/2008



Legend

-  Sunrise Fire 1996
-  Como Fire 2000
-  Adrian Fire 2007
-  Churchill Canyon Allotment

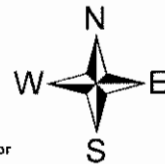
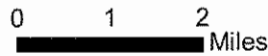

United States Department of the Interior
 Bureau of Land Management (BLM)
 Carson City Field Office
 5665 Morgan Mill Road
 Carson City, NV 89701

No warranty is made by the BLM as to the accuracy, reliability or completeness of these data for individual or aggregate use with other data. 01/08/2008

IV. Management Evaluation

I. Actual Use

Grazing Year	Type of Livestock	Winter Season	Winter Use (AUMs)	Spring/ Summer Season	Spring/ Summer Use (AUMs)	TOTAL ACTUAL USE (AUMs)
1975	Sheep	12/01 - 02/15	1,167	04/01 - 07/15	2,833	4,000
1976	Sheep	12/01 - 02/15	1,167	04/01 - 07/15	2,833	4,000
1977	Sheep	12/01 - 02/15	527	04/01 - 07/15	2,833	3,360
1978	Sheep	12/01 - 02/15	743	04/01 - 07/15	2,120	2,863
1979	Sheep	12/01 - 02/15	743	04/01 - 07/15	2,168	2,911
1980	Sheep	12/01 - 02/15	479	04/01 - 07/15	2,168	2,647
1981	Sheep	12/27 - 01/21	522	04/01 - 07/15	2,168	2,690
1982	Sheep	12/18 - 02/07	546	05/01 - 07/15	2,294	2,840
1983	Sheep	12/28 - 01/10	207	05/01 - 07/15	1,407	1,614
1984	Sheep	No Use	-	04/01 - 07/15	1,787	1,787
1985	Sheep	No Use	-	No Use	-	-
1986	Sheep	02/20 - 02/28	84	No Use	-	84
1987	Sheep	No Use	-	03/01 - 05/26	800	800
1988	Sheep	No Use	-	No Use	-	-
1989	Sheep	No Use	-	05/19 - 07/12	143	143
1990	Sheep	No Use	-	No Use	-	-
1991	Sheep	No Use	-	No Use	-	-
1992	Sheep	No Use	-	No Use	-	-
1992-1993	Cattle	11/20-03/10	1,037	No Use	-	1,037
1993-1994	Cattle	11/20-02/28	996	03/01-03/10	41	1,037
1994-1995	Cattle	11/19-02/28	456	03/03-05/15	293	749
1995-1996	Cattle	11/24-02/28	730	03/01-04/30	459	1,189
1996-1997	Cattle	11/16-02/28	729	03/01-04/19	347	1,076
1997-1998	Cattle	11/22-02/28	649	03/01-06/02	613	1,262
1998-1999	Cattle	11/22-02/28	814	03/01-06/02	723	1,537
1999-2000	Cattle	12/15-02/28	500	03/01-05/25	565	1,065
2000-2001	Cattle	12/26-02/28	461	03/01-05/22	630	1,091
2001-2002	Cattle	11/13-02/28	547	03/01-05/21	497	1,044
2002-2003	Cattle	01/05-02/28	326	03/01-05/19	372	698
2003-2004	Cattle	11/22-02/28	728	03/01-05/25	526	1,254
2004-2005	Cattle	11/14-02/28	787	03/01-06/01	474	1,261
2005-2006	Cattle	11/13-02/28	870	03/01-06/01	793	1,663
2006-2007	Cattle	11/12-02/28	1,074	03/01-05/30	674	1,750
2007-2008	Cattle	No Use	-	No Use	-	0

J. Precipitation

The annual and growing season precipitation data shown in Appendix IX on page 40 is from the Carson City, Lahontan, Smith Valley (6N), Wabuska (5SE) and Yerington, Nevada Weather Stations. These are the closest weather stations with consistent and reliable data. Elevations within the Churchill Canyon allotment range from approximately 4,700 feet along the Churchill Canyon drainage in the northeast to over 9,000 feet on Mt. Como in the southwest portion of the allotment. The elevations of the weather stations are below the lowest portion of the allotment. Although the total amount of precipitation received in the Churchill Canyon allotment for a given year probably exceeded the amount received at the weather stations. Data from the weather stations is presented to document cyclic patterns in precipitation amounts. The weather station data is useful in relating wet and dry precipitation cycles to actual use and utilization data. The precipitation data is also useful in determining what time of year precipitation was received so it can be related to the potential for plant growth.

Broad scale drought conditions are also listed in Appendix X on page 41. Data is available between 2000 and 2008. This data set indicates drought conditions existed in the general area of the allotment between 2001-2004 and between 2007-2008.

K. Livestock Utilization

Utilization refers to the proportion (usually percentage) of the current years forage production that is consumed and or destroyed by grazing animals. Recommended utilization levels depend upon how fully each forage species in the plant community can be defoliated and still maintain or improve in vigor. Proper use refers to the maximum degree of use by grazing, expressed as a percent deemed to be physiologically correct from the standpoint of plant vigor, reproduction, longevity and regrowth potential. The utilization goal within the Churchill Canyon Allotment was moderate (41%-60%) or lower utilization of key plant species. To avoid confusion it is important to note that moderate as defined in BLM's Technical Reference "Utilization Studies and Residual Measurements" is much higher than is commonly referred to in range management literature which defines moderate use as (21%-40%).

Many factors influence livestock use and distribution such as topography, distance from water, plant community characteristics, type of livestock, weather and fencing. In the case of Churchill Canyon cattle have primarily used the accessible areas of the allotment, the flat lands and valley bottoms near water and incidental use has occurred on the mountain slopes. Fencing, water haul sites and salting have been used as management tools to increase livestock distribution and decrease use levels. These management tools are depicted the maps on pages 8-10. As noted in the utilization data in appendix XI on pages 42-47 water hauling did not occur during all years, nor were all water haul areas used. Livestock utilization within the Churchill Canyon Allotment is summarized below and a detailed discussion of use levels and conditions within the allotment by grazing year is included in Appendix XI.

During the past 15 years, livestock use has typically occurred within the northeastern portion of the allotment (Sario Well pasture), between November 1 and March 15. The Sario Well pasture has been closed to cattle grazing twice, during the 2003-2004 and 2007-2008 seasons. The majority of the livestock grazing use has occurred on the level and gently sloping terrain

in the valley bottom (Churchill Canyon) within a mile of the water wells. The valley bottom and side canyons have deeper soils which support more productive plant communities. The characteristic plant community types in these deeper soils include Basin Big Sagebrush in the Churchill Canyon drainage and salt desert shrub communities. The valley side slopes are comprised of shallow rocky soils and support less productive low sagebrush plant communities. Livestock use is much lower on the side slopes in comparison to the valley bottoms. The reasons for reduced use levels includes: 1) Increased distance from water so livestock have to travel further; 2) Livestock movement is more difficult due to rocky soils and steeper slopes; 3) Decreased forage palatability due to smaller plant size and increased dead plant material due to less frequency of grazing.

Data on livestock use of key perennial plant species in the Sario Well pasture was collected at the end of ten grazing seasons and prior to the start of one grazing season. The management goal of moderate (41%-60%), to below moderate use of key perennial plant species was met four times. Use goals were not met during the other seven grazing seasons due to heavy utilization levels in the valley bottom. During three out of the four seasons when utilization goals were met the pasture received above average precipitation levels, forage production was above average and the livestock stocking rate was increased. The remaining one season when livestock utilization levels were met the pasture received below average precipitation levels but there was an average abundance of forage; livestock stocking rates were reduced and the pasture had been rested the previous season.

During the first grazing season utilization goals were not met but this is not surprising since the cattle were new to the allotment and the area had not been grazed for several years. As livestock become familiar with new surroundings distribution usually improves and when dead biomass is removed and new shoots begin to grow forage becomes more palatable. During five of the seasons when use goals were not met there were back to back years when over utilization occurred. Little to no plant re-growth occurred after the first grazing season and over utilization occurred again the next season. Livestock stocking rates for these years was close to permitted use. The remaining year when livestock utilization goals were not met there was an average amount of forage at the start of the grazing season but the livestock stocking rate (699 AUMs) was too high for the amount of available forage in livestock use areas.

Livestock use has typically occurred within the southern portion of the allotment (JW ranch pasture), between November 1 and June 1. The Como burn portion of the pasture was closed to cattle grazing between 2000-2003. The patterns of livestock grazing use have varied in response to changing conditions within the pasture. Until July of 1996 the eastern slope of the Pine Nut range had a mix of mountain, Wyoming and low sagebrush plant communities. Dense stands of pinyon and juniper trees were present within many of these communities and there was a low abundance grasses and forbs below the shrubs and trees. The sunrise fire burned 2,957 acres along the northern allotment boundary in July 1996. The native plant communities along the eastern Pine Nut slope near the southern allotment boundary were intact until October 2000 when the Como fire burned an additional 1,744 acres. In 2003 a cross fence was build do divide the JW Ranch pasture and separate the burned areas on the eastern slope of the Pine Nut range from the Wyoming big sagebrush and low sagebrush communities in the valley bottom and Buckskin range. Data on livestock use of key perennial plant species in the JW Ranch pasture was collected at the end of ten grazing seasons and prior to the start of one grazing season.

Seven years of use data were collected in the Buckskin Range. The management goal of moderate (41%-60%), to below moderate use of key perennial plant species was met three times. Use goals were not met during the other four grazing seasons due to heavy utilization levels in the canyon bottoms. During one of the seasons when utilization goals were met the pasture received above average precipitation levels, forage production was above average and livestock stocking rate was increased. The remaining two seasons when livestock utilization levels were met the pasture received below average precipitation levels but there was an average abundance of forage; livestock utilized between 197-240 AUMs of forage.

Utilization goals were not met in the Buckskin range during the first grazing season. During one season, use goals were not met due to little plant re-growth after the previous grazing season. The remaining two years when livestock utilization goals were not met there was an average amount of forage at the start of the grazing season but the livestock stocking rate was too high (353 AUMs) for the amount of available forage in the useable grazing areas.

Eight years of use data were collected on various portions of the eastern slope of the Pine Nut Range. In general the utilization goal of moderate (41%-60%), to below moderate use of key perennial plant species was met for the uplands during seven out of eight years. During four out of the eight years the riparian meadows were over utilized. During one year utilization goals were not met on the lower slopes of the Como burn at a stocking rate of 211 AUMS during March to May. Utilization goals were not met for meadows within the Sunrise burn at a stocking rate of 351 AUMs during November to December. However, utilization goals were met at a stocking rates 163-202 AUMs during April and May.

Livestock use has typically occurred within the northwestern portion of the allotment (Como pasture), between March 1 and May 15. The pasture was closed to cattle grazing during the 2007-2008. This pasture can only be utilized in years when sufficient winter moisture is received to fill the dry lakes and dugout tank. Utilization data was collected during five years and utilization goals were met during each year data was collected. At a stocking rate of 186 AUMs utilization goals were met.

L. Trend

Trend is a determination of the direction of change in the current plant community and associated soils in relation to management goals. The current trend for plant communities within the Churchill Canyon Allotment is primarily static to downward. The photo trend plots indicate a static to downward trend due to an uneven age class distribution within the plant communities. Mature plants are dying out and there is a scarcity of young perennial replacement plants. The frequency data also indicates a downward trend. The frequency of perennial plant species significantly declined between 2000-2007. The exception to this decline was an increase of Bottlebrush squirreltail at Key Area #2, which is not a positive trend. Squirreltail is considered an increaser species meaning it is less palatable to cattle than the key plant species which receive higher grazing use. Higher grazing use of key species reduces the competitive abilities of the key species within the plant community in comparison to less palatable increaser species. Under these conditions the frequency of less favorable species increases while the frequency of desired key species declines. The exception to overall downward vegetative trend within the allotment is the Como burn. Vegetative trend within the burn is slightly upward due to marginal new plant establishment following the fire; however, there is also evidence of soil erosion. Frequency and Photo trend plot and data are

presented in appendices I & II on pages 23-29. Line intercept, density and photo trend plot data related to the Como Burn are in Appendix III on pages 30-31. Please reference the map on Page 5 for monitoring locations.

M. Rangeland Health

With the exception of the burn areas (Sunrise & Como) which are dominated by annual vegetation, the dominant plants within the allotment are tree and shrub species. In comparison to potential plant communities as described by the natural resource conservation service, perennial grass and forb densities are much lower than the density that would be required to meet the production levels described in the ecological site descriptions. There are also fewer key plant species than would be expected based on site potential. The natural resources within the Churchill Canyon allotment are very heterogeneous and patchy. There are areas where perennial grasses are present in the shrub interspaces, areas where grasses can only be found within the shrub canopies and other areas where perennial grass densities are so low grass is almost absent. In general the soils within the allotment have been stable. Observations within the allotment, photo trend plot data and riparian assessments determined that the exceptions to soil stability have been limited to discrete areas in the uplands and around spring sources in the meadows. Appendix IV on pages 32-34.

N. General Wildlife Habitat

Several terrestrial wildlife habitats occur within the allotment area as described in the Nevada Wildlife Action Plan. The major wildlife habitat types include,

Intermountain Cold Desert Scrub – Historically, this habitat would have been dominated by Indian rice grass. Spiny hopsage, shadscale and chenopods can be found at the lower elevations of this allotment. Grasses, Ephedra species and shadscale are also found. Some bud sagebrush can be found. Wildlife species associated with this habitat type include pale kangaroo mouse, Great Basin collared lizard and black-throated sparrow.

Sagebrush – At middle elevations, Wyoming big sagebrush dominates on this allotment. Grasses and forbs such as globemallow and lupine would be used by mule deer, pronghorn and desert bighorn. The half-shrub Eriogonum (buckwheat) can be used extensively by mule deer as fall forage. Higher elevations are also dominated by Wyoming big sagebrush. Bitterbrush would not be a co-dominant with this sagebrush species. Mountain big sagebrush dominates much of the upper elevation. Low sagebrush can be found as small inclusions associated with specific soil types. Wildlife species such as Great Basin pocket mouse, sagebrush lizard and sage sparrow.

Lower Montane Woodlands - Singleleaf pinyon and Utah juniper are the dominant vegetation types in this habitat. Mountain mahogany may be present at the upper elevations of this habitat. Forbs and grasses are sparse, especially as the canopy closure increases. Cliffrose and bitterbrush are key mule deer forage species in this habitat type. Wildlife species such as short-horned lizards, gray fox and gray vireo can be found in this habitat type.

Timber / aspen - Small amounts of true timber and aspen occur at heads of canyons. These areas are inclusions within the pinyon-juniper woodland, riparian or mountain shrub habitat type. They don't support a different assemblage of wildlife species than the surrounding area.

Springs and Springbrooks - There are no rivers and the only springbrook outflows associated

with springs in this allotment. Some springs have riparian vegetation mostly intact, but in other areas, mesic vegetation such as sage brush is encroaching on the riparian vegetation. In some cases, livestock has damaged the vegetation and water source. A 1973 report identified livestock overuse of meadows. Some pinyon juniper trees are encroaching on the water source and will eventually replace the riparian vegetation. Where riparian areas exist, roses, willow, rushes and sedges can be found. The east side of the allotment has a riparian area that supports overstory cottonwood trees. This area burned in summer 2007. Wildlife species associated with this habitat type include wandering garter snake, shrew species and Cooper's hawk.

This allotment is within the BLM designated Pine Nut Habitat Management Plan area.

Mule deer use this allotment. They are associated with the various elevations of woodland habitat in this allotment although a few can be found at lower elevations on the fringes of valleys. Pinyon-juniper encroachment at the mid-elevation was reported in a 1973 report. This is an issue, but some of these areas have burned since 1973. Mid-elevation areas are still key travel corridor areas that connect to the Carson River. Mule deer also use the higher elevations of the allotment which are key mule deer summer ranges. Mule deer fawning would occur within this allotment. A one-mile radius around springs within mule deer range is considered key fawning habitat in spring / summer. Some springs associated with fawning areas are impacted by roads / trails that allow vehicles and OHV use during fawning season.

The southwest portion of the allotment is key deer winter range. Most of it burned in the Como wildfire and in many places, only desert peach came back. Deer use this, but it doesn't have the nutritional value that cliffrose, bitterbrush or mountain big sage has during winter. Deer are currently wintering all along the eastern lower to mid-elevation areas of the allotment. During open winters, the current livestock use patterns that are confined to fairly small areas, would leave good areas for deer use. During hard winters, current livestock use patterns could cause significant overlap with area needed by deer. Mule deer habitat in the allotment is functional, but far from ideal.

Historically, pronghorn were present in all valleys of Nevada. Pronghorn antelope occur in the allotment and appear to be increasing. Pronghorn use the eastern portion of the allotment to mid-elevation. These animals typically need open spaces with good forb and shrub availability. Key areas for pronghorn have not been delineated in the allotment, but it is expected that a kidding ground would be located somewhere on the low elevation alluvial fans. General condition of the allotment for pronghorn is good and functional since these animals favor mid-seral vegetation conditions.

The allotment is within historic bighorn range, but isn't occupied. It is still considered potential habitat by NDOW.

The Churchill Canyon allotment is occupied black bear habitat.

This grazing allotment lies within the Pine Nut Sage Grouse Population Management Unit (PMU). The upper elevations are key sage grouse use areas. The mid-level meadows are key sage grouse use areas. Lekks have been identified in this allotment. There are droppings and tar patches associated with the hills above the meadows and near springs in the upper elevations.

Mountain and California quail are present in this allotment. Mountain quail benefit from riparian vegetation adjacent to shrub lands. Mourning dove can be found in the allotment.

The exotic chukar partridge can be found in the allotment.

Current conditions in this allotment are functional for general wildlife species.

O. Special Status Species

Federal Status Species

There are no federally listed species of animals associated with this allotment.

BLM Sensitive Species

There are 32 BLM sensitive species of wildlife and species whose habitats are associated with this allotment. BLM sensitive species associated with this allotment are shown in Appendix V on page 35.

The general condition of the grassland and shrub component of this allotment is mixed. Some is declining in condition due to drought or livestock use, some is being maintained and some is relatively untouched. Species diversity, especially of forbs and grasses is poor. In normal precipitation years, range conditions would not be having a negative effect on prey or sensitive species of wildlife that used shrubs. Current range condition is not conducive for prey species or sensitive species that depended primarily on grass and forb production, but livestock grazing is not causing this situation.

Some BLM sensitive species use every habitat within the allotment. Some of these species do not occur because of a natural lack of habitat type in this specific allotment. Current habitat conditions, other than drought years, are meeting habitat requirements for BLM sensitive species that would be expected in this allotment.

Migratory Birds

Four biomes associated with Neo-tropical Migratory Birds (NTMB) Species of Continental Importance occurs on this allotment. NTMB species associated with this allotment are shown in Appendix VI on pages 36-37. The general condition of the grassland and shrub component of this allotment is mixed. Some is declining in condition due to drought, some is being maintained. Species diversity, especially of forbs and grasses is poor due to drought conditions. In normal precipitation years, range conditions would not be having a negative effect on prey or NTMB species that use shrubs. Current range condition, due to drought, is not conducive for NTMB species that depended primarily on grass and forb production, but livestock grazing is not contributing to this condition. Riparian areas used by migratory birds are in poor to fair condition. These provide functional habitat at a low level for migratory birds.

Some migratory bird species use every habitat within the allotment. Some species do not occur because of a natural lack of habitat type in this specific allotment. Current habitat conditions, other than drought years, are meeting habitat requirements for migratory birds that would be expected in this allotment.

Other

William's combleaf (*Polyctenium williamsiae*) is a small perennial plant found along the

margins of playa lakes in western Nevada and eastern California. The species is a BLM special status species and is listed with the State of Nevada as “critically endangered” and is protected by state law (NNHP, 2006).

There are several playa lakes within the Churchill Canyon Allotment which serve as suitable habitat for the William’s combleaf. At this time, there are only two known occurrences of this plant within the allotment. Several of the playa lakes were excavated, as part of a range improvement project, to concentrate the shallow surface water into deeper pools of water that would minimize evaporation and thereby make water available to domestic livestock and wildlife for a longer period of time.

The excavation of the playa lakes resulted in a significant alteration to the local hydrology. Prior to the playa lake excavations, precipitation accumulated in the playa lake which saturated the sandy-gravel shorelines, creating the necessary moisture conditions to support the William’s combleaf. In addition, invasive shrub and tree competitors were reduced or eliminated from the playa lake shores as high water levels drowned out these more xeric species. The excavation of the playa lakes reduced the amount of time the playa lake shores were inundated resulting in less water infiltration and consequently less water available for the William’s combleaf. The lessening of shoreline inundation allowed invasive species to occupy the site. Several surveys to locate William’s combleaf plants along the shores of the excavated playa lakes have not found any plants within these areas and it is concluded from survey results in the Churchill Canyon Allotment and other sites in the Sweetwater Mountains that extirpation of the William’s combleaf is a direct consequence of the altered hydrology. Without restoration of the local hydrology, the excavated playa lake habitat will remain unable to support any William’s combleaf populations.

P. Riparian Habitat

Eighteen separate riparian areas were assessed on the Churchill Canyon allotment between June 5 and June 21, 2007. Other riparian areas on the allotment were not assessed because of difficult access and a low likelihood of impacts. Riparian data is summarized within the tables in appendix IIX on pages 38-39. Table 1 provides some basic data for each location, and Table 2 summarizes the 2007 condition ratings for all assessed sites. Table 3 compares 2007 ratings with ratings based on assessments performed in 2000.

Table 1 shows overall ratings are generally positive. Thirty-eight percent of lentic areas are in proper functioning condition (PFC) or functional-at-risk in an upward trend (FAR-UP). Fifty-six percent are functional-at-risk in an unknown trend (FAR-?), which largely reflects the rating of 62 acres in the Big Meadow enclosure. Big Meadow had some characteristics of a properly functioning system, but also had some severe localized hoof impacts around springs. In addition, desirable forbs were lacking, while undesirable species, such as wild iris were common. Only six percent of lentic areas were in a downward trend (FAR-DN) or nonfunctional (NF).

Though a PFC rating means the riparian standard for rangeland health is being met for a particular site, this does not mean that the area is in a desired condition. Almost all the riparian areas assessed on the allotment had impacts from livestock grazing to some degree, including those rated as PFC. Because there is good spring flow at most sources, the riparian areas tend to be resilient and can recover from impacts.

Though the overall ratings in 2007 were not poor, the trends from previous years were not always favorable. Table 3 shows that some areas have improved somewhat since 2000, but others have declined. Willow Spring went from PFC to FAR-DN, JW Spring went from PFC to FAR-?, and Mud Spring went from FAR-DN to NF. These areas could have been susceptible to severe impacts from heavy use because they are small. The decline in condition could also be partly in response to drought conditions in 2007.

This suggests that the grazing impacts from current management are enough to prevent continued improvement of riparian areas on the allotment. Future management should consider relieving grazing pressures on the riparian through exclosures, providing rest during the growing season, and other means.

V. Conclusions

In the context of a historical perspective great strides have been made to improve both management and resource conditions within the Churchill Canyon Allotment. In the context of this evaluation period both management and resource conditions need further improvement. The ecological systems within the allotment are holding together. The soils are mostly stable, nutrient cycling is occurring and key plant species are present. In general the standards and guidelines (S&Gs) for rangeland health within the allotment were met, but management concerns were identified within the S&G determination document and this evaluation. There is general concern for the long term health of native plant communities within the allotment. The densities of key perennial plant species are low and declining. The age class distribution of key plant species is skewed toward older mature plants. A large proportion of the allotment has been affected by wildfire and post fire recovery of native plant communities has been slow. Due to the presence of the invasive species cheatgrass the systems that burned are at risk of crossing an ecological threshold if they burn again before native plant communities are reestablished. Management issues include: 1) over-utilization of plant species by livestock; 2) high stocking rates for livestock; 3) concern that recent livestock management is not sustainable in the long-term; 4) the decline of key plant species between 2000-2007; 5) the season of use for livestock grazing in relation to riparian health and wildlife habitat needs; 6) post fire recovery of plant communities; and 7) the disparity between functioning natural systems verses systems that are functioning and meeting desired conditions to achieve resource management goals. Copies of both the Standards and Guidelines for Nevada's Sierra Front-Northwestern Great Basin Area as well as the 2007 S&G determination are available from the Carson City Field Office.

Many of the natural resource objectives for this allotment are not being met at this time. There are a variety of reasons why the productivity of the rangeland has not been enhanced, ground cover has not increased, the physiological needs of key plant species have not been met, and wildlife habitat conditions are not improving, including plant community dynamics, drought and livestock grazing. The densities of key perennial species are low and there is intense competition with other plants for soil moisture and nutrients. The competitive pressure from other vegetation to a large degree determines a plants tolerance to grazing. There is also intense competition between livestock, wild horses and wildlife for the use of key plant species. The competition for scarce resources has further been exacerbated by drought conditions and livestock over utilization of key perennial plant species. The over utilization of plant species by livestock grazing does not provide for the physiological needs of key plant species. Recovery from grazing requires the ability to replace photosynthetic tissues and retain a competitive position in the plant community. Intense competition from neighboring plants may be more suppressive of foliage generation than heavy defoliation but the two in combination are additive negative effects which

affect plant production and survivability. Excessive defoliation reduces both root system activity and leaf area which limits a plants ability to compete for and utilize soil moisture and nutrients. In arid environments resources are scarce and excessive defoliation of palatable species results in the forfeiture of these resources to less palatable species. Heavy grazing contributes to the suppression of key perennial plant species, reduced plant re-growth and reduced cover which has resulted in a failure to provide for the physiological needs of key plant species and improve wildlife habitat conditions within the portions of the allotment that were heavily utilized by livestock.

The permitted stocking rate for livestock within the allotment is 1074 AUMs, but temporary non-renewable use has been authorized during eight of the last sixteen years. The utilization and actual use data have shown that there are periods when additional forage above the 1074 AUMs is available, however, the data has also shown over utilization of key plant species due to poor livestock distribution and reduced plant re-growth following grazing. The use of water haul sites, salt and fencing has improved livestock distribution but did not alleviated the over utilization that occurred at higher stocking rates. The current fall through spring season of use is the most favorable timing to maximize livestock distribution. Cattle are more willing to travel and utilize slopes in the early spring and late fall but are not well adapted to utilizing steep slopes. Due to the over utilization of key plant species, declines in the frequency of key plant species and the current low proportion of key plant species within the plant communities, actual livestock management needs to be changed to favor the physiological needs of key species and enhance wildlife habitat. Maintaining a conservative stocking rate for livestock, setting a light (21%-40%) utilization level for key species and no longer authorizing TNR use during periods of above average production would favor key perennial plant species by leaving more leaf (photosynthetic tissues) surface area and encouraging root growth (moisture and nutrient uptake). It would also help improve wildlife habitat by providing for the physiological needs of key plant species and leaving residual vegetation for wildlife forage/browse and cover.

Livestock use periods during the spring also need to be adjusted to ensure plant re-growth. Plant re-growth is needed to ensure the long term health of individual plants and to provide increased cover for wildlife habitat values. The period of use in the Sario Well pasture should end on or before February 15th to ensure that livestock use within salt desert shrub plant communities occurs while plants are dormant. In the JW Ranch pasture livestock use needs to end by May 15th and spring use between February 15th-May 15th needs to be limited to half of the pasture to increase cover in key wildlife habitats and allow for rest during the spring grazing season.

There have been wide annual fluctuations in forage quantities within the allotment, but fluctuations in forage production, drought and years of above average forage production are all normal occurrences on arid rangelands. What is important is to manage for these conditions. Livestock numbers were increased during eight grazing seasons to utilize additional forage. Increased stocking resulted in over utilization of key plant species and insufficient re-growth of those species following grazing. In general it's important to set a conservative stocking rate but in the case of the Churchill Canyon Allotment it is especially important due to the current downward trend of native plant communities. The stocking rate not only needs to provide for the health of the natural resources but also should provide some consistency for the livestock operation. If a conservative stocking rate is used it is not necessary to frequently adjust livestock numbers due to small variations in forage production between years. However, it is important to note that even a conservative stocking rate will not factor in severe drought conditions. During periods of prolonged or extremely dry resource conditions it is still necessary to reduce stocking to provide for the health of the plant communities.

VI. Technical Recommendations

1. Maintain the current permitted livestock stocking rate at 1074 AUMs and season of use November 1 till May 15.
2. Do not authorize additional Temporary Non-Renewable Use.
3. Livestock utilization of key perennial plant species should not exceed light (21%-40%) use levels.
4. Sario Well Pasture: Recommended Season of Use November 1 till February 15: Recommended Stocking Rate 350-400 AUMs.
5. JW Ranch Pasture: Recommended Season of Use November 1 till May 15, livestock use could occur anywhere within the pasture November 1 till February 15, after February 15th use would occur in the Buckskins in odd numbered years and in the Como and Sunrise Burns in even numbered years. Use could occur in Big Meadow anytime during the grazing season but should not exceed two weeks in duration. Use could occur any time during the grazing season in Upper Spring Gulch. Recommended Stocking Rates Buckskins 200-250 AUMs, Como Burn 100-150 AUMs, Sunrise Burn 150-200 AUMs, Big Meadow 50-75 AUMs, Upper Spring Gulch 20-30 AUMs.
6. Como Pasture - Recommended Season of Use March 15 till May 15: Recommended Stocking Rate 150-200 AUMs.
7. Construct low (2-3 feet high) barriers at riparian areas along the Sunrise Pass Road to prevent vehicles from driving through the meadows. In areas where there is enough room between the road and riparian area, create a vehicle turnout along the road and place the barrier between the turnout and riparian area.
8. At Mud Spring head cutting is occurring and the spring is being drained. Plant woody species at nick points to improve gradient control. Fence the spring area to protect the new plantings from browsing. Pipe water outside of the fence to provide water for wildlife, wild horses and livestock.
9. Apply for funding to reseed areas in the JW Ranch pasture. Broadcast seed in the fall and use concentrated livestock trampling to improve soil seed contact. Livestock would be fed and watered to not only ensure concentrated trampling but to minimize use on perennial plant species. Soil seed contact is necessary to enable plant establishment and the use of livestock is preferable to mechanical tilling or plowing to minimize the disturbance impacts on existing perennial plant species
10. Construct the proposed fences in the Sario Well and JW Ranch pastures depicted within the maps on pages 8-9. When the proposed fence east of Big Meadow is constructed remove the eastern boundary of the existing fence. This would enlarge and management unit and reduce grazing use within the meadow.
11. Manage riparian areas to prevent the expansion of existing Iris populations and if possible reduce the size of existing populations.

Two key areas were established in 1982 within the Churchill Canyon allotment. A 40-inch frame size has been used for all plant species. Key area #1 has 20 transects with 10 quadrats per transect and key area #2 has 10 transects with 20 quadrats per transect, for total of 200 presence or absence frames per location. All values were compared to the Baseline Data collected in 1982. Bolded values indicate a significant difference at ($P>0.05$). ND indicates no data was collected

Frequency data is as follows:

Key Area #1	Achy = Orhy*	Acth = Stth*	Artr	(Elcl)	(Epne)
09/03/82	1%	5%	44%	34%	42%
06/19/85	1%	5%	50%	45%	42%
06/16/88	1%	11%	43%	73%	42%
08/21/91	2%	7%	38%	53%	47%
08/19/94	1%	11%	23%	56%	28%
07/01/98	2%	8%	42%	83%	45%
11/08/00	4%	18%	52%	86%	52%
06/18/07	1%	12%	39%	48%	44%

95% Confidence Intervals:

Orhy*-1%	Stth*-5%	Artr-44%	(Elcl)-34%	(Epne)-42%
0-4	2-9	37-51	27-41	35-49

Key Area #2	Achy = Orhy	Artr	(Elcl)	(Epne)
09/08/82	10%	ND	7%	ND
06/19/85	7%	19%	6%	34%
06/16/88	12%	22%	28%	40%
08/08/91	8%	15%	3%	38%
08/19/94	11%	12%	6%	26%
07/01/98	13%	23%	10%	35%
06/09/00	21%	20%	9%	42%
06/18/07	14%	1%	15%	32%

95% Confidence Intervals:

Orhy (10%)	Artr (19%)	(Elcl) (7%)	(Epne) (34%)
6-14	14-24	3-11	27-41

* As identified on page 16 of the Nevada Rangeland Monitoring Handbook (February of 2007), it is important to have frequency data in the mid range (10-90%) for proper analysis.

Five photo trend plots were established in the allotment by the BLM in 1975. In the data summary below graphic representations of the photo plots are displayed. The diagrams are not drawn to scale and are provided as visual aid to ensure consistency in data analysis.

Photo Trend Plot #1 (TP1) is located in the southern portion of the allotment (T14N, R23E, Sec. 21). Photos were taken in 7/76, 6/77, 7/79, 7/80, 8/83, 7/86, 8/90, 8/93, 9/96, 8/98, 10/01, 9/06 and 6/07. The characteristic vegetation at this location is low sagebrush (*Artemisa arbuscula*) Desert & Thurber's needlegrass (*Achnatherum speciosum & thurberianum*) and Nevada Ephedra (*Ephedra nevadensis*).

The initial datasheet from August 1975 indicates there are eight needlegrass plants within the plot. The squares in the diagram labeled with an "A" represent mature needlegrass plants that were present within the plot in 1975 and were still alive in 2007. The square labeled with a "B" represents a young needlegrass plant that was recorded on the 1975 datasheet, but was not always recorded as an individual plant in subsequent years because it was growing inside of another needlegrass plant. It is not clear in the photographic record that there are two individual plants until the 1990s; however, this plant was also present in 1975 and still alive in 2007. These five needlegrass plants were present within the plot between 1975 and 2007. The other three young needlegrass plants recorded in 1975 are presumed to have perished sometime before 1979; the plants are not visible in the photographic record and are not recorded on subsequent datasheets. The datasheet from 1980 identifies two additional needlegrass plants within the plot in the top right corner. The two plants identified on the datasheet are not visible in the 1980 photograph but the seed stalk of a third plant is visible just outside of the plot. All three plants are visible in the 1983 photograph. These new needlegrass plants are located on the plot margin. In subsequent photographs these three needlegrass plants are sometimes shown outside the plot due to slight variations in plot placement, but in later photographs the plants have grown into the plot. To ensure consistency in data analysis these plants are always counted within the plot. In the diagram below these plants are represented by a square labeled as "C". These three plants established sometime between 1979 and 1980 and were still present in 2007. Between 1990 and 1993 two additional needlegrass plants established within the plot. These plants were present in 2007 and are represented in the diagram by squares labeled with a "D".

The initial datasheet from 1975 indicates there are four squirreltail (*Elymus elymoides*) plants within the plot. One squirreltail plant is not recorded in subsequent data and is presumed not to have survived past 1975. In the diagram squirreltail plants are represented by a circle, at the locations labeled with the number one, there was some inconsistency in the data between 1979 and 1980 regarding the number of plants at each location. However, there was one plant at each location in 1975 and in 2007. The circle labeled with the number two represents a squirreltail plant that was present within the data and photographic records between 1975 and 1986. The plant is no longer visible in the 1990 or subsequent photographs. A new squirreltail plant established within the plot between 1986 and 1990 this plant was still present in 2007. This plant is represented by the circle labeled with the number three in the diagram.

Between 1983 and 1986 a buckwheat (*Eriogonum Sp.*) plant established within the plot. This plant was still present in 2007 and is represented by a triangle in the diagram.

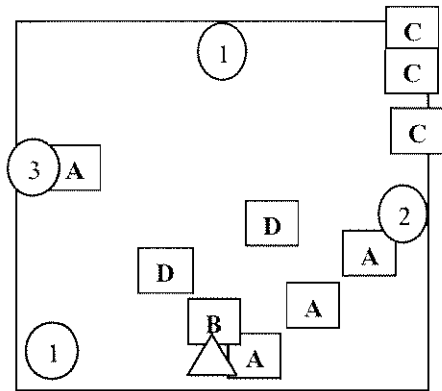

In all of the photographs the soils appear to be stable, there is no noticeable evidence of soil deposition nor pedestalling.

The panoramic views show very few perennial grasses between the low sagebrush during the 1970s and 1980, but seed stalks are visible on the sagebrush. Although grass seedlings are not visible in the 1980 photos the datasheet indicates that young grass plants were establishing. In the photographs between 1983-1998 perennial grasses, the annual cheatgrass and sagebrush with seed stalks are very visible. The most recent establishment of perennial grasses within the photo plot occurred between 1986-1993, which coincided with a period of little to no livestock use between 1985-1992 and indications of average to above average moisture during the growing season in 1995, 1996 & 1998. The BLM rated this site in an upward trend in 1999 due to the stable soils, good plant vigor and evidence of perennial plant recruitment and establishment. In the photographs between 2001 and 2007, very few seed stalks are visible on either perennial shrubs or grasses, plant vigor appears reduced and older needlegrass plants appear to be dying, this has coincided with below average precipitation between 1999-2004. Five needle grass plants have persisted within the plot between 1975-2007. In all of the photographs the centers of the plants are dead and grass shoots are growing around the outside margins of the root crowns. Through time the plants have grown larger and the size of the dead centers have increased. In the 2007 photographs grass shoots are no longer growing around the entire circumference of the root crowns and these plants appear to be dying out. Two needlegrass plants which established within the plot between 1990-1993 are approximately fifteen years old and represent the youngest age class.

The photographic record indicates this is a closed stand of mature plants which maintain dominance. There is an unnatural age class distribution due to the absence of seedlings and the scarcity of young plants. Because the mature grass plants are dying out and younger replacement plants are lacking it is important that these plants be given every opportunity to reproduce and establish. **The trend as of 2007 at this site is static to downward.**

Photo Trend Plot #2 (TP2) is located in the northwest portion of the allotment (T15N, R23E, Sec. 19). Photos were taken in 8/75, 6/77, 7/79, 7/80, 8/83, 7/86, 8/90, 8/93, 9/96, 8/98, 10/01 and 6/07. The characteristic vegetation at this location is Wyoming big sagebrush (*Artemisia tridentata wyomingensis*), antelope bitterbrush (*Purshia tridentata*), singleleaf pinyon (*Pinus monophylla*) and Utah Juniper (*Juniperus Osteosperma*).

The initial datasheet from August 1975 indicates there are five sagebrush and one bitterbrush plant within the plot. In 1979 there were five sagebrush seedlings within the plot and one squirreltail grass plant. However, by the next year the datasheet indicates that two of the sagebrush seedlings and the squirreltail plant are no longer present in the plot. The initial photo and the photos through 2007 show one bitterbrush plant (represented by the circle) and three sagebrush plants (represented by squares) in the plot. The 2007 datasheet also indicates that three squirreltail plants (represented by triangles) are present under the canopy of the bitterbrush plant.

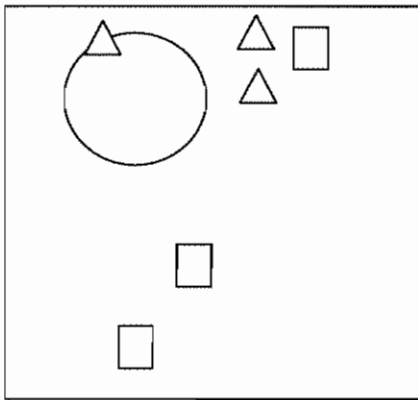

There is noticeable rill channeling in the photographs between 1980-1993. After 1993 the rills appear to be stabilizing. In the 2001-2007 photographs litter from pinyon and juniper trees is visible in the photographs.

The panoramic photos from 1975 through 1980 show pinyon and juniper trees but no perennial bunch grasses. Photos from 1983 through 2007 show that the trees and shrubs have been increasing in size. The 1998 and subsequent photos of the plot show that the bitterbrush plant has dominated the plot and grown over the top of the three sagebrush plants. Shrub vigor has been declining, many dead shrub branches are visible. Pinyon and Juniper trees are also encroaching on the sides of the plot. There are no bunchgrasses or new shrub seedlings visible in the photographs.

The photographic record indicates this is a stand of mature plants in which the trees are beginning to dominate and the shrub and grass undersory is dying. There is an unnatural age class distribution due to scarcity of young shrub and grass plants. **The trend as of 2007 at this site is static to downward.**

Photo Trend Plot #3 (TP3) is located in the north east portion of the allotment (T15N, R24E, Sec. 30). Photos were taken in 9/75, 7/76, 6/77, 7/79, 7/80, 8/83, 7/86, 8/90, 8/93, 9/96, 8/98, 10/01 and 6/07. The characteristic vegetation at this location was low sagebrush (*Artemisa arbuscula*) and winterfat (*Krascheninnikovia lanata*).

The initial photo and datasheet from 1975 show two winterfat plants and one low sagebrush plant within the plot. In the diagram below, the winterfat plants are represented by the squares and the sagebrush by the triangle. The sagebrush plant and the winterfat plant labeled as "B" were still present within the plot in 2007. The winterfat plant labeled as "A" dies sometime between 1986 and 1990. A rabbitbrush (*Ericameria nauseosa*) plant which is represented by a circle in the diagram established within the plot between 1983 and 1986. The plot is not placed properly in the 1986 photograph but the rabbitbrush is visible along the bottom edge of the photograph and in the 1990 photograph the rabbitbrush is a mature plant. The rabbitbrush dies between 2001 and 2007. A squirreltail (*Elymus elymoides*) grass plant established within the plot sometime after 1980 and is still present in 2007. The grass plant is located under the sagebrush canopy and is not visible in the photographs. In the diagram below the squirreltail is represented by a triangle.

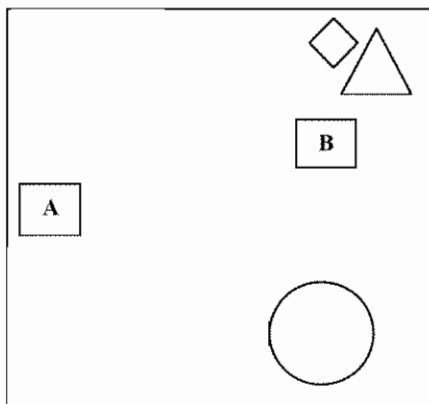

The soil is very rocky and in all of the photographs the soils appear to be stable, there is no noticeable evidence of soil deposition nor pedestalling. In the more recent photographs plant litter is present and appears to be remaining in place.

During the 1970's plant density was low and perennial plant size is small and bare ground is very visible in the photographs. From 1975 to 1979 no perennial grass species are visible. During the 1980's and 1990's there are visible increases in plant size and density. In the 1980 and 1983 photographs the annual cheatgrass is apparent. Perennial grass plants are visible in the panoramic views from 1986, 1993 and 1998 photos. In the panoramic photos winterfat has decreased while squirreltail and low sagebrush have both increased. The BLM rated this site in an upward trend in 1999 due to the stable soils, good plant vigor and evidence of perennial plant recruitment and establishment. In the photographs between 2001 and 2007, very few seed stalks are visible on either perennial shrubs or grasses, plant vigor appears reduced and sagebrush plants appear to be dying.

There is an unnatural age class distribution due to the scarcity of seedlings and young plants. Because the mature shrubs are dying out and younger grass and shrubs are lacking it is important that these perennial plants be given every opportunity to reproduce and establish. **The trend as of 2007 at this site is static to downward.**

Photo Trend Plot #4 (TP4) is located in the southwest portion of the allotment (T14N, R23E, Sec. 31). Photos were taken in 9/75, 7/76, 6/77, 8/79, 7/80, 8/83, 7/86, 8/90, 8/93, 9/96, 8/98, 10/01 and 6/07. The characteristic vegetation is Thurber Needlegrass (*Achnatherum thurberianum*) and Wyoming Big Sagebrush (*Artemisia tridentata wyomingensis*).

The initial datasheet from 1975 indicates four needlegrass and three squirreltail plants were present within the plot. The 1979 datasheet indicates three needlegrass, two squirreltail and one skeleton weed (*Pleiocanthus spinosus*) are present within the plot. In the 1979 photograph only the base of the grass plants are visible, no grass seed stalks are present. After the 1977 photograph no green shoots are visible on the grass root crowns in subsequent photos. Therefore these grass plants are presumed to have died between 1977-1979. Between 1979 and 1983 no living perennial grasses are visible within the plot. One grass plant is visible within the plot in the 1986 photograph. This needlegrass plant is represented in the diagram below by the diamond. In the 1990 photograph two squirreltail plants are visible in the upper left and right corners of the plot, but no living perennial grasses are visible within the plot in the 1993. In all of the photographs between 1996-2001, the needlegrass which is represented by the diamond and the skeletonweed which is represented by the circle labeled with a number one are visible. In 2007 five skeletonweed plants (represented by circles) and three squirreltail plants (represented by squares) are present within the plot.

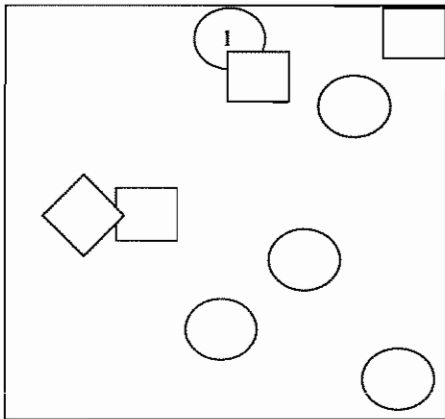

The panoramic photos between 1975-1998 show a dense stand of big sagebrush with scattered pinyon and juniper trees. In the photographs during this time period the soils appear to be stable, there is no noticeable evidence of soil deposition nor pedestalling. The photographic record indicates this is a stand of mature sagebrush plants in which the trees are encroaching and the grass understory is dying. The BLM rated this site in a static trend in 1999 due to the stable soils the closed stand of mature sagebrush plants.

In October of 2000 this area burned in the Como Fire. In the 2001 photograph all of the sagebrush is gone and horsebrush is the only visible shrub species which survived the fire. Bare ground and the annual cheatgrass are also very visible in the photograph. Between 2001 and 2007 there is evidence of soil movement. Just outside of the photo plot in the upper left corner is a large rock which is clearly visible in all the photographs between 1977-2001. In the 2007 photo the rock is almost completely covered by soil and litter. The plants that survived the fire are growing larger and eight new plants established within the plot. **The trend is static to slightly upward.**

Photo Trend Plot #5 (TP5) is located in the northeast portion of the allotment (T15N, R24E, Sec. 21). Photos were taken in 9/75, 7/76, 6/77, 7/79, 7/80, 8/83, 7/86, 8/90, 8/93, 9/96, 8/98, 10/01 and 6/07. The characteristic vegetation is Indian ricegrass (*Achnatherum hymenioides*), shadscale (*Atriplex confertifolia*), and bailey greasewood (*Sarcobatus baileyi*).

The datasheets from 1975-1980 indicate there are seven ricegrass and one winterfat plant within the plot. In the diagram below the ricegrass is represented by the circles and the winterfat by the square. The ricegrass labeled with the number "1" is not visible in photographs after 1980. The ricegrass labeled with "2" is not visible after 1990. Starting in 1990 the placement of the photo plot is shifted to the left. Starting in 1993 and in subsequent photos the plot is shifted to the left and downward. The ricegrass labeled with a "3" is visible in photographs through 1993. The ricegrass labeled with "4" is growing within the winterfat plant and is visible in the photographs through 1986. The ricegrass plants labeled as "5" and the winterfat plant are present within the plot between 1975-2007.

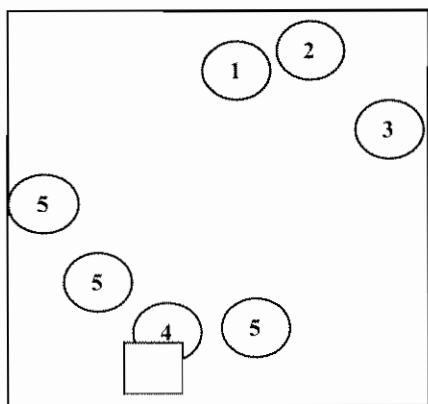

Soil movement is visible in the 1996 photographs and a road drainage ditch is visible in the panoramic photographs upslope from the plot.

Only the base of the ricegrass plants are visible between 1976 and 1980 no grass seed stalks are visible. The panoramic views show very few perennial grasses between the shrubs from 1976 till 1980. Indian ricegrass is very visible in the panoramic photos from 1993 and 1998. Perennial grass plants have seed stalks but are very small in the 1996 photo. Only the base of the ricegrass plants are visible between 2001 and 2007 photographs the plants are grazed and no grass seed stalks are visible.

The number of Indian ricegrass plants within the plot decreased from seven to three plants between 1975-1993 and no new perennial grasses have established within the plot. **The trend is static to downward.**

This data was derived from 100 foot line intercept transects, 5' X 5' Photo Trend Plots and Density Hoops (Ten 1m² density hoops / 200' transect).

Name of Monitoring Area: Como #1					
Percent Cover from 100' Line Intercept Transect					
Plant Type	Year Data Was Collected				
	2001	2002	2003	2005	2007
Forb	0.13	2.00	3.30	6.50	7.00
Grass	0.11	0.20	0.40	0.40	0.15
Shrub	0.12	0.35	6.00	7.10	24.11
Plant Density within a 10m ² Area					
Plant Type	Year Data Was Collected				
	2001	2002	2003	2005	2007
Forbs	28	28	19	48	53
Grasses	1	4	0	1	0
Shrubs	8	11	8	8	7
Plant Density within a 5' X 5' Photo Trend Plot					
Plant Type	Year Data Was Collected				
	2001	2002	2003	2005	2007
Forb	7	3	4	20	8
Grass	1	1	1	4	1
Shrub	4	5	4	4	5

Name of Monitoring Area: Como #2					
Percent Cover from 100' Line Intercept Transect					
Plant Type	Year Data Was Collected				
	2001	2002	2003	2005	2007
Forb	0.07	0.20	0.60	No Data	0
Grass	0.05	0.30	0.20	0.80	0
Shrub	1.52	1.00	4.81	10.70	17
Plant Density within a 10m ² Area					
Plant Type	Year Data Was Collected				
	2001	2002	2003	2005	2007
Forbs	5	5	2	No Data	31
Grasses	3	4	3	4	2
Shrubs	8	6	3	4	11
Plant Density within a 5' X 5' Photo Trend Plot					
Plant Type	Year Data Was Collected				
	2001	2002	2003	2005	2007
Forbs	10	4	5	2	1
Grasses	13	7	6	6	3
Shrubs	7	5	5	4	2

Name of Monitoring Area: Como #3					
Percent Cover from 100' Line Intercept Transect					
Plant Type	Year Data Was Collected				
	2001	2002	2003	2005	2007
Forb	0.05	0.34	4.70	5.60	7.20
Grass	0.08	0.13	0.40	0.50	0.37
Shrub	2.53	7.76	11.20	12.30	13.41
Plant Density within a 10m ² Area					
Plant Type	Year Data Was Collected				
	2001	2002	2003	2005	2007
Forbs	45	81	92	51	52
Grasses	12	12	10	7	10
Shrubs	15	15	11	10	11
Plant Density within a 5' X 5' Photo Trend Plot					
Plant Type	Year Data Was Collected				
	2001	2002	2003	2005	2007
Forbs	5	8	3	7	3
Grasses	6	5	5	5	6
Shrubs	8	3	6	5	4

Name of Monitoring Area: Como #4 - Unburned	
Percent Cover from 100' Line Intercept Transect	
Plant Type	Year Data Was Collected
	2001
Forb	0
Grass	0.40
Shrub	9.18
Plant Density within a 10m ² Area	
Plant Type	Year Data Was Collected
	2001
Forbs	4
Grasses	11
Shrubs	8
Plant Density within a 5' X 5' Photo Trend Plot	
Plant Type	Year Data Was Collected
	2001
Forbs	2
Grasses	10
Shrubs	5

Interdisciplinary teams visited nine sites within the Churchill Canyon Allotment during 2007. These teams interpreted the indicators of rangeland health at each of the sites visited (Technical Reference 1734-6 Version 4).

Ecological Site Number	Rangeland Health
026XY010NV	<p><u>Rangeland Health #6</u> Soil Site/Stability - This site was rated as unstable. Water flow patterns, terracettes and pedestalling were common. Gullies were present. Sheet flow and soil loss were apparent. Soil and litter deposition was accumulating around the base of shrubs. Hydrologic Function - The capacity of the sites to capture store and release water has been reduced. The site is dominated Pinyon and Juniper trees and sagebrush. The density of perennial grass plants is much lower than expected for this type of site. Integrity of Biotic Community - Functional plant groups are present at these sites but the abundance of those groups is not what is expected. Dominant plant species by cover is Pinyon, Juniper and Wyoming sagebrush. Based on the ecological site description needlegrass is expected as a dominant species on this type of site. Perennial grass densities are lower than expected. Litter amount, plant production, and reproductive capability were slightly reduced due to recent climatic conditions.</p>
026XY016NV	<p><u>Rangeland Health #1, #2 & #3</u> Soil Site/Stability - These sites were rated as relatively stable. There is little evidence of recent rill formation. Minimal amounts of soil deposition around the base of shrubs. Some evidence of pedestal and terracette formation. Bare areas are higher than expected for this type of site. There is no compaction layer in the soil. Hydrologic Function - The capacity of the sites to capture store and release water has been slightly reduced. The sites are dominated by perennial shrubs and the density of perennial grass plants is lower than expected for this type of site. Water infiltration rates have been slowed by these changes in plant community composition. There is little evidence of litter movement within the sites. Integrity of Biotic Community - Functional plant groups are present at these sites but the abundance of those groups is not what is expected. Dominant plant species by cover is Wyoming sagebrush. Based on the ecological site description needlegrass is expected as a co-dominant species on this type of site. Perennial grass densities are lower than expected. Litter amount, plant production, and reproductive capability were slightly reduced due to recent climatic conditions. Slight plant mortality was observed. Cheatgrass is scattered throughout the un-burned sites and is co-dominant with desert peach on the burn.</p>

026XY023NV	<p>Rangeland Health #5</p> <p>Soil Site/Stability - This site was rated as relatively stable. There is no evidence of recent rills or water-flow patterns. Some evidence of pedestalling of grass plants. No gullies are present at the site. Some soil loss has occurred in plant interspaces. There is no compaction layer in the soil.</p> <p>Hydrologic Function - The capacity of the sites to capture store and release water has been slightly reduced. The sites are dominated by perennial shrubs and the density of perennial grass plants is lower than expected for this type of site. Water infiltration rates have been slowed by these changes in plant community composition. There is evidence of litter movement within the sites.</p> <p>Integrity of Biotic Community - Functional plant groups are mostly present at the site but the abundance of those groups is not what is expected. Dominant plant species by cover is low sagebrush. Based on the ecological site description needlegrass is expected as the dominant species on this type of site. Perennial grass densities are lower than expected. Litter amount, plant production, and reproductive capability were slightly reduced due to recent climatic conditions. Slight plant mortality was observed. Cheatgrass and Juniper are scattered throughout the site.</p>
026XY025NV	<p>Rangeland Health #8 & #9</p> <p>Soil Site/Stability - These sites were rated as relatively stable. There is little evidence of recent rill or water flow patterns. Active benches of soil deposition behind obstacles (terraces) is rare. Some evidence of past pedestal formation. No gullies are present at these sites. There is no compaction layer in the soil.</p> <p>Hydrologic Function - The capacity of the sites to capture store and release water has been slightly reduced. The unburned site is dominated by perennial shrubs and the density of perennial grass plants is lower than expected for this type of site. On the burned site there has been a shift in perennial species dominance from low sagebrush to horsebrush. There is also an abundance of annual species (cheatgrass & mustard) on the burn. Water infiltration rates have been slowed by these changes in plant community composition. There is little evidence of litter movement within the sites.</p> <p>Integrity of Biotic Community - Functional plant groups are present at these sites but the abundance of those groups is not what is expected. Dominant plant species by cover at the unburned site is low sagebrush. Based on the ecological site description needlegrass and blue grass are expected as a co-dominant species on this type of site. Perennial grass densities are lower than expected. Litter amount, plant production, and reproductive capability were slightly reduced due to recent climatic conditions.</p>

Ecological Site Number	Rangeland Health
027XY018NV	<p data-bbox="383 268 688 296">Rangeland Health #4 & #7</p> <p data-bbox="383 302 1326 449">Soil Site/Stability - These sites were rated as relatively stable. There is little evidence of recent rill formation. Minimal amounts of soil deposition around the base of shrubs but the deposition is common on the sites. Some evidence of pedestal formation. No gullies are present at these sites. Some soil loss has occurred in plant interspaces. There is no compaction layer in the soil.</p> <p data-bbox="383 455 1326 602">Hydrologic Function - The capacity of the sites to capture store and release water has been slightly reduced. The sites are dominated by perennial shrubs and the density of perennial grass plants is lower than expected for this type of site. Water infiltration rates have been slowed by these changes in plant community composition. There is evidence of some litter movement within the sites.</p> <p data-bbox="383 609 1326 779">Integrity of Biotic Community - Functional plant groups are present at these sites but the abundance of those groups is not what is expected. Dominant plant species by cover is Bailey's greasewood. Based on the ecological site description Indian ricegrass is expected as a co-dominant species on this type of site. Perennial grass densities are lower than expected. Litter amount, plant production, and reproductive capability were slightly reduced due to recent climatic conditions.</p>

Appendix V. BLM Sensitive Species associated with Churchill Canyon Allotment Page 1 of 1

Animal

Golden Eagle – *Aquila chrysaetos*
Ferruginous Hawk - *Buteo regalis*
Northern Goshawk - *Accipiter gentilis*
Burrowing owl - *Athene cunicularia*
Long-billed Curlew – *Numenius americanus*
Juniper Titmouse - *Baeolophus griseus*
Pinyon Jay - *Gymnorhinus cyanocephalus*
Greater sage-grouse- *Centrocercus urophasianus*
Mountain quail - *Oreortyx pictus*
Cooper’s Hawk – *Accipiter cooperii*
Sharp-shinned Hawk- *Accipiter striatus*
Prairie Falcon – *Falco mexicanus*
Peregrine Falcon- *Falco peregrinus*
Swainson’s Hawk- *Buteo swainsoni*
Western Snowy Plover- *Charadrius alexandrinus*
Loggerhead shrike- *Lanius ludovicianus*
Gray vireo- *Vireo vicinior*
Pallid bat – *Antrozous pallidus*
Spotted bat – *Euderma maculatum*
Long-eared myotis – *Myotis evotis*
Fringed myotis – *Myotis thysanodes*
Yuma myotis – *Myotis yumanensis*
Silver-haired bat - *Lasionycteris noctivagans*
California myotis - *Myotis californicus*
Small-footed myotis -*Myotis ciliolabrum*
Long-eared myotis -*Myotis evotis*
Little brown myotis - *Myotis lucifugus*
Long-legged myotis - *Myotis volans*
Townsend’s big-eared bat - *Corynorhinus townsendii*
Hoary bat - *Lasiurus cinereus*
Western pipistrelle bat - *Pipistrellus hesperus*
Brazilian free-tailed bat - *Tadarida brasiliensis*

Plant

William’s combleaf – *Polyctenium williamsiae*

Appendix VI. Neo-tropical Migratory Birds, Species of Continental Importance on Churchill Canyon Allotment Page 1 of 2

Salt Desert Scrub – This biome experiences harsh climactic variation and is often dominated by salt-tolerant shrubs. Species of concern associated with this habitat type in the land sale area are,

Loggerhead Shrike – *Lanius ludovicianus* (Neel 1999)

Burrowing Owl – *Athene cunicularia* (Neel 1999)

Issues related to this habitat type include physical destruction of salt desert shrubs, habitat conversion and use of rangeland pesticides (Neel 1999).

Western Shrublands (Beidleman 2000) – Shrubsteppe was identified as the highest priority habitat for conservation for breeding birds. This habitat type supports the largest nesting-bird species list of any upland vegetation type in the West (Beidleman 2000). Species of concern associated with this habitat type in the plan area,

Shrub-Steppe

Sage grouse – *Centrocercus urophasianus* (Beidleman 2000)

Brewer's sparrow – *Spizella breweri* (Beidleman 2000)

Sage Sparrow – *Amphispiza belli* (Neel 1999, Beidleman 2000, Nevada Wildlife Action Plan 2006)

Sage Thrasher – *Oreoscoptes montanus* (Neel 1999, Beidleman 2000, Nevada Wildlife Action Plan 2006)

Issues related to this habitat type include fragmentation from man-caused activities. Threats to this habitat type include overgrazing of grasses and forbs that alter community structure, invasion of non-native grasses and fire suppression / crown-killing wildfire (Beidleman 2000). Loss of shrub understory, increasing human infrastructure which fragments and degrades habitat, and increases soil erosion was also identified (Nevada Wildlife Action Plan 2006).

Woodland – Pinyon-juniper woodlands are characteristic of this habitat type Species of concern associated with this habitat type in the plan area,

Gray Flycatcher – *Empidonax wrightii* (Beidleman 2000)

Gray Vireo - *Vireo vicinior* (Beidleman 2000)

Juniper Titmouse – *Baeolophus ridgwayi* (Beidleman 2000)

Mountain Bluebird – *Sialia currucoides* – cavity nester (Neel 1999)

Pinyon Jay – *Gymnorhinus cyanocephalus* (Neel 1999)

Western Bluebird-*Sialia mexicana* – snags / hollow tree (Neel 1999)

Issues related to this habitat type include fragmentation from man-caused activities (Beidleman 2000).

Appendix VI. Neo-tropical Migratory Birds, Species of Continental Importance on Churchill Canyon Allotment Page 2 of 2

Riparian – This habitat type supports the highest bird diversity of any western habitat type but is one of the rarest. Species of concern associated with this habitat type in the plan area,

Calliope hummingbird – *Stellula calliope*- (Beidleman 2000)

Issues related to this habitat type include de-watering and alteration of water flows / channels, road construction, nonnative species, logging, recreation and overgrazing (Beidleman 2000). Groundwater withdrawal and shallow aquifer pollution were mentioned as specific Nevada issues (Nevada Wildlife Action Plan 2006).

Table 1. 2007 Riparian Assessment Data for the Churchill Canyon Allotment

Name	Date Assessed	UTM Northing	UTM Easting	Rating ¹	Acres ²	Miles	Management Recommendations
Big Meadow (inside fence)	6/5/2007	4324955	288834	FAR-?	62		Treat weeds
Big Meadow (outside fence)	6/5/2007	4324537	289764	FAR-UP	20		Treat weeds; monitor old headcuts
Sunrise Pass Rd Meadow #1	6/6/2007	4326705	288275	FAR-UP	2.4		Consider alternate drainage under road
Sunrise Pass Rd Meadow #2	6/6/2007	4326255	288757	PFC	11		Treat weeds
Sunrise Pass Rd Meadow #3	6/6/2007	4325785	289199	PFC	1		Treat weeds; monitor old headcuts
Sunrise Pass Rd Meadow #4	6/6/2007	4325556	289343	FAR-?	6		
Unnamed Seep	6/7/2007	4328320	290701	FAR-?	<0.1		
N. Presto Spring	6/7/2007	4328532	290806	FAR-?	0.1		Repair exclosure
S. Presto Spring	6/7/2007	4328049	290669	FAR-?	0.2		
Lower S. Presto	6/7/2007	4328077	290728	FAR-DN	0.1		
Presto Spring (aka Exclosure)	6/7/2007	4328374	290758	PFC	0.1		
U. Spring Gulch	6/8/2007	4320157	287991	PFC	11		
L. Spring Gulch	6/8/2007	4320502	288889	FAR-DN	7		
Willow Spring	6/20/2007	4327548	294657	FAR-DN	1		
Sario Ranch	6/20/2007	4330404	294163	FAR-?	2.6		Treat weeds
JW Spring	6/20/2007	4325155	293208	FAR-?	0.2		
Mud Spring	6/21/2007	4336506	288118	NF	0.1		Explore funding fencing & gradient control by permittee
Upper Churchill Canyon	6/7/2007	4328996	290585	PFC	3	0.5	

Table 2. Summary of 2007 Riparian Assessments for the Churchill Canyon Allotment

Rating	Acres	Percent of Total	Miles	Percent of Total
PFC	26.1	20	0.5	100
FAR-UP	22.4	18	-	-
FAR-DN	8.1	6	-	-
FAR-?	71.1	56	-	-
NF	0.1	<0.1	-	-
Total	127.8	100	1.1	100

1 Rating key: PFC = Proper Functioning Condition
 FAR-UP = Functional-At-Risk with an Upward Trend
 FAR-DN = Functional-At-Risk with a Downward Trend
 FAR-? = Functional-At-Risk with an Unknown Trend
 NF = Nonfunctioning

2 Acreages were determined by delineating riparian areas in ArcMap from 2006 digital color imagery, except for relatively small systems which were GPSed in the field. Acreage of Upper Churchill Canyon assumes an average width of 50 feet.

Table 3. Comparison of 2000 and 2007 Riparian Data for the Churchill Canyon Allotment

Name	2000 Rating	2007 Rating	Acres ³	Miles
Big Meadow	FAR-UP	FAR-?/FAR-UP	62	
Sunrise Pass Rd Meadow #1	FAR-UP	FAR-UP	2.4	
Sunrise Pass Rd Meadow #2	FAR-UP	PFC	11	
Sunrise Pass Rd Meadow #3	FAR-UP	PFC	1	
Sunrise Pass Rd Meadow #4	FAR-UP	FAR-?	6	
Presto Spring (aka Exclosure)	PFC	PFC	0.1	
Upper Spring Gulch	PFC	PFC	11	
Willow Spring	PFC	FAR-DN	1	
JW Spring	PFC	FAR-?	0.2	
Mud Spring	FAR-DN	NF	0.1	
Upper Churchill Canyon	PFC	PFC	3	0.5

³ Acreages shown in Table 3 were determined in 2007 with GPS or GIS. Because areas were estimated in the field during 2000 assessments they were not as precise as the 2007 acreages. Direct comparisons between the 2000 and 2007 acreages should not be made..

Year	Total Annual Precipitation in Inches					Percent of Average Precipitation (Total)					Precipitation During Growing Season (March-June) in Inches					Percent of Average Precipitation (Growing Season (March-June))				
	CC	L	S	W	Y	CC	L	S	W	Y	CC	L	S	W	Y	CC	L	S	W	Y
	1974	6.68	1.23	4.78	3.11	4.15	64%	27%	77%	69%	81%	1.96	.48	.86	0.20	.16	75%	28%	40%	11%
1975	11.90	ND	4.10	3.99	4.63	114%	ND	66%	88%	91%	5.13	ND	1.77	1.3	2.43	197%	ND	83%	68%	125%
1976	6.58	3.56	5.48	4.65	4.88	63%	79%	88%	102%	96%	1.47	1.04	1.72	1.3	1.24	56%	60%	81%	68%	64%
1977	10.35	4.49	5.02	4	3.79	99%	99%	81%	88%	74%	1.67	1.97	2.72	2.06	2.11	64%	115%	128%	108%	108%
1978	7.61	6.45	4.00	3.56	4.23	73%	142%	65%	78%	83%	1.29	2.59	1.26	.53	1.75	49%	151%	59%	28%	90%
1979	10.09	5.34	3.48	2.55	2.10	97%	118%	56%	56%	41%	1.55	1.41	.66	.74	.87	59%	82%	31%	39%	45%
1980	14.42	5.70	6.63	5.88	4.23	138%	126%	107%	130%	83%	2.45	1.65	1.48	1.76	.98	94%	96%	69%	93%	50%
1981	10.95	4.22	3.26	3.95	3.40	105%	93%	53%	87%	67%	1.81	2.28	1.70	2.7	1.68	69%	133%	80%	142%	86%
1982	19.21	8.73	10.56	7.43	6.46	184%	193%	170%	164%	127%	3.44	2.47	2.93	2.11	1.82	132%	144%	138%	111%	93%
1983	5.72	10.92	10.70	7.28	10.6	55%	241%	173%	160%	207%	4.37	2.75	2.49	1.52	3.25	167%	160%	117%	80%	160%
1984	8.61	4.57	5.44	3.75	4.28	83%	101%	88%	83%	84%	1.56	.72	1.52	1.37	1.05	60%	42%	71%	72%	54%
1985	6.28	4.13	5.27	4.35	8.23	60%	91%	85%	96%	161%	1.01	2.3	1.88	.93	3.98	39%	134%	88%	49%	204%
1986	14.88	4.19	7.06	2.82	4.38	143%	92%	114%	62%	86%	2.50	.78	1.07	1.09	1.26	96%	45%	50%	57%	48%
1987	6.81	4.23	7.43	4.68	5.20	65%	93%	120%	103%	102%	1.53	1.97	3.46	2.38	2.30	59%	115%	162%	125%	88%
1988	4.85	3.15	3.95	3.69	3	47%	70%	64%	81%	59%	0.81	1.41	1.78	1.54	1.38	31%	82%	84%	81%	53%
1989	9.07	5.14	6.12	4.46	5.47	87%	113%	99%	98%	107%	4.57	1.91	3.71	2.10	3.22	175%	111%	174%	111%	165%
1990	4.00	3.81	3.80	3.29	4.31	38%	84%	61%	72%	85%	0.56	2.44	0.94	2.03	2.60	21%	142%	44%	107%	133%
1991	7.41	5.27	5.86	4.26	5.78	71%	116%	95%	94%	113%	3.64	2.47	2.67	1.26	2.84	139%	144%	125%	66%	146%
1992	4.68	2.51	4.26	4.19	4.28	45%	55%	69%	92%	84%	2.03	0.46	2.11	2.99	2.91	78%	27%	99%	157%	149%
1993	8.28	5.77	5.74	6.33	8.37	79%	127%	93%	139%	164%	2.36	3.16	2.35	3.28	3.22	90%	184%	110%	173%	165%
1994	6.39	2.62	5.37	3.65	3.69	61%	49%	87%	80%	72%	2.20	1.85	2.47	2.21	1.93	84%	108%	116%	116%	99%
1995	16.94	7.28	13.22	8.01	8.42	162%	161%	213%	176%	165%	9.54	4.65	8.23	5.30	5.15	366%	270%	386%	279%	264%
1996	19.99	5.51	9.44	6.66	5.38	191%	122%	152%	147%	105%	4.26	2.19	2.94	2.97	2.70	163%	127%	138%	156%	138%
1997	9.96	3.36	5.79	3.93	4.49	95%	74%	93%	86%	88%	1.44	1.22	0.16	1.75	2.05	55%	70%	7%	91%	105%
1998	15.08	6.01	11.15	8.74	4.91	144%	132%	179%	191%	96%	5.74	4.77	6.01	5.82	4.15	218%	278%	278%	303%	213%
1999	6.77	3.93	3.36	1.86	2.51	65%	87%	54%	41%	49%	0.64	1.52	1.41	0.83	1.36	24%	87%	65%	43%	70%
2000	7.83	3.51	3.96	4.18	2.10	75%	77%	64%	91%	41%	1.42	1.03	1.39	1.66	0.68	54%	59%	64%	86%	35%
2001	5.39	3.03	5.18	2.66	2.89	52%	67%	83%	58%	56%	1.07	0.62	1.53	0.60	0.68	41%	36%	71%	31%	35%
2002	8.28	1.99	5.30	2.96	1.80	79%	44%	85%	65%	35%	1.42	0.66	1.22	0.86	0.39	54%	38%	56%	45%	20%
2003	5.83	2.95	3.60	2.83	3.48	56%	65%	58%	62%	68%	2.21	0.75	0.48	0.76	0.21	84%	43%	22%	40%	11%
2004	6.90	1.60	6.01	3.27	4.30	66%	35%	96%	72%	84%	0.86	0.89	1.02	0.96	0.65	33%	51%	47%	50%	33%
2005	14.84	2.75	9.68	5.62	4.95	142%	61%	155%	123%	97%	3.00	2.49	1.16	2.73	1.35	114%	143%	54%	142%	69%
2006	8.90	4.26	5.18	4.98	3.19	85%	94%	83%	109%	62%	3.00	3.60	2.07	2.50	1.05	127%	207%	96%	130%	54%
AVE	10.43	4.53	6.20	4.54	5.10						2.61	1.72	2.13	1.90	1.95					

CC = Carson City Weather Station - Average is for the years 1948-2007; L = Lahontan Weather Station - Average is for the years 1948-2007
 S = Smith 6 N Weather Station - Average is for the years 1973-2007; W = Wabaska 5 SE Weather Station - Average is for the years 1972-2007
 Y = Yerington Weather Station - Average is for the years 1914-2007; AVE = Average Precipitation
 <90% = Below Average; 90-110% = Average; > 110 Above Average

Dates	Drought Severity
April 10, 2001 - June 19, 2001	Moderate
June 19, 2001 - July 3, 2001	Moderate to Severe
July 3, 2001 - January 1, 2002	Extreme
January 1, 2002 - January 8, 2002	Severe
January 8, 2002 - March 12, 2002	Dry to Moderate
June 4, 2002 - November 5, 2002	Moderate
November 5, 2002 - November 12, 2002	Severe
November 12, 2002 - December 24, 2002	Dry to Moderate
February 11, 2003 - April 29, 2003	Moderate to Severe
April 13, 2004 - August 10, 2004	Moderate to Severe
August 10, 2004 - December 28, 2004	Extreme
December 28, 2004 - January 4, 2005	Moderate to Severe
January 23, 2007 - July 3, 2007	Moderate to Severe
July 3, 2007 - January 8, 2008	Extreme
January 8, 2008 - March 4, 2008	Moderate to Severe

Grazing Year Allotment Actual Use Precipitation	Description of Grazing Use and Forage Conditions	Utilization Levels
1993-1994 1037 AUMs Precipitation +	<p>Precipitation data from weather stations surrounding the allotment indicate average to above average amounts of precipitation were received during the 1993 growing season. This data is consistent with observations of vegetation within the allotment. At the start of the 1993 grazing season there was an average abundance of forage available. In the Sario Well pasture ricegrass plants had produced seed and were average to above average in size. Livestock use was heavy in the valley bottom and slight to light on the side hills at the end of the grazing season in the spring of 1994.</p> <p>In the JW Ranch pasture needlegrass plants were below average to average in size and produced few seed heads. Use in the eastern portion of the Buckskins south of Willow Spring was heavy. Use on other slopes within the Buckskins was slight. In the canyon bottoms in the Buckskins and along the main Churchill Canyon road use was light to moderate. Around the Big Meadow and JW Ranch use was heavy. On the eastern slope of the Pine Nut range use was slight to light.</p>	Sario Well + JW Ranch +/-
1994-1995 749 AUMs Precipitation -	Total precipitation was below average in 1994 and observations of vegetation within the allotment indicate grass plants grew a few inches following grazing but did not produce seed.	No Data
1995-1996 1189 AUMs Precipitation +	<p>Both total and growing season precipitation levels were above average in 1995. In the Sario Well pasture livestock use was light to moderate in the valley bottom and none to slight on the side hills at the end of the grazing season in the spring of 1996.</p> <p>In the JW Ranch pasture use was moderate in the canyon bottoms in the Buckskins and along the main Churchill Canyon road. Use on the side hills in the Buckskins and on the eastern slopes of the Pine Nut Range was slight to light. Use in the big meadow, around Presto Spring and JW Ranch was Heavy. The Sunrise Fire occurred in June of 1996.</p>	Sario Well + JW Ranch +/-

Grazing Year Allotment Actual Use Precipitation	Description of Grazing Use and Forage Conditions	Utilization Levels
1996-1997 1076 AUMs Precipitation +	<p>Precipitation data indicated above average precipitation levels for 1996 but little to no re-growth occurred on grass plants following the 1995-1996 grazing season. At the start of the 1996-1997 grazing season in the Sario Well pasture use levels were still at light to moderate levels in the valley bottom. At the end of the grazing season utilization was heavy in Churchill Canyon, moderate in the salt desert shrub and low sage communities next to the canyon and slight to light on the side hills.</p> <p>In the JW Ranch pasture grass plants were below average to average in size at the start of the growing season, and very few seed stalks were visible. Use in the valley bottoms was moderate to heavy. Use on the sidehills was slight to light. Use was moderate to severe in Upper Spring Gulch.</p> <p>In the Como Pasture use was moderate along the main roads (back county byway and jeep trail to the use cage) and slight along the northern allotment boundary.</p>	<p>Sario Well -</p> <p>JW Ranch -</p> <p>Como +</p>
1997-1998 1262 AUMs Precipitation -	<p>The precipitation data for the 1997 growing season indicates average and below average precipitation levels at the weather stations. At the end of the 1997-1998 grazing season use in the Sario Well pasture was heavy in lower Churchill Canyon, moderate in the salt desert shrub communities, and light to slight in the low sage side hills.</p> <p>In the JW Ranch Pasture use was light to moderate in the valley bottoms, slight on the side hills and heavy around Presto Spring and in the Big Meadow.</p> <p>Use in the Como pasture was light along the main roads.</p>	<p>Sario Well -</p> <p>JW Ranch +</p> <p>Como +</p>
1998-1999 1537 AUMs Precipitation ++	<p>Precipitation data for the 1998 growing season was above average. This data is consistent with observations of vegetation within the allotment. At the start of the 1998 grazing season there was an above average abundance of forage available. Grass plants were larger than average in size and had produced seed. At the end of the grazing season use within the Sario Well pasture was light to moderate in the valley bottoms and light to slight on the side hills.</p> <p>Use in the JW Pasture was light in the valley bottoms and slight on the eastern slope of the Pine Nut range.</p> <p>Use in the Como pasture was slight along the main roads.</p>	<p>Sario Well +</p> <p>JW Ranch +</p> <p>Como +</p>

Grazing Year Allotment Actual Use Precipitation	Description of Grazing Use and Forage Conditions	Utilization Levels
1999-2000 1065 AUMs Precipitation -	<p>Precipitation data for the 1999 growing season was below average. Note use data was collected in September 2000 after plant re-growth to assess available forage for the next grazing season (2000-2001). In the Sario Well pasture use within the valley bottom was primarily moderate. Use on the side slopes was slight to light.</p> <p>In the JW ranch pasture two areas within the Buckskins received heavy use. The meadows along the Sunrise Pass Road received moderate use. Use on the eastern slope of the Pine Nuts was light. The Como fire occurred in October of 2000.</p> <p>Use in the Como pasture was heavy along the main roads.</p>	Sario Well - JW Ranch -
2000-2001 1091 AUMs Excluding the Como Burn Precipitation -	<p>Precipitation data for the 2000 growing season was below average. At the start of the 2000-2001 grazing season there was very little re-growth of forage plants from the previous grazing season in the Sario Well Pasture. A drought letter was sent instructing the permittee to only trail livestock in and out of the moderately used Churchill Canyon valley bottom and to encourage livestock use in the side canyons and hills. At the end of the grazing season use within the valley bottom was heavy.</p> <p>In the JW Ranch pasture use was light in the main valley along the main Churchill Canyon road and slight to light in the Sunrise burn. The Como burn was rested from grazing.</p>	Como - Sario Well - JW Ranch +
2001-2002 1044 AUMs Excluding the Como Burn Precipitation -	<p>Precipitation data for the 2001 growing season was below average. Observations of vegetation within the allotment, at the start of the 2001-2002 grazing season indicated there was an average abundance of forage available. Grass plants were below average to average in size and had produced seed. At the end of the grazing season in the Sario Well pasture use was heavy in the valley bottom.</p> <p>In the JW Ranch pasture, the Como burn was rested from grazing.</p>	Sario Well -

Grazing Year Allotment Actual Use Precipitation	Description of Grazing Use and Forage Conditions	Utilization Levels
2002-2003 698 AUMs Excluding the Sario Well Pasture and Como Burn Precipitation -	<p>Data for the 2002 growing season indicated below average precipitation. Observations of forage within the Sario Well pasture indicated very little re-growth had occurred since the previous grazing season. The Sario Well pasture was rested from livestock grazing during the 2002-2003 grazing season.</p> <p>In the JW Ranch and Como pastures there was a below average to average abundance of forage available at the beginning of the grazing season. Grass plants re-grew following the 2001-2002 grazing season but did not produce seed heads. Water was hauled to five locations in the Buckskins to redistribute livestock use. The Como burn was rested from grazing due to the small size of establishing plants. The fence dividing the JW Ranch Pasture was constructed in 2003.</p>	<p>Sario Well No Use</p> <p>JW Ranch No Data</p>
2003-2004 1254 AUMs Precipitation -	<p>Precipitation data for the 2003 growing season was below average. Observations of vegetation within the allotment at the start of the 2003-2004 grazing season indicated there was an average abundance of forage available. In the Sario Well pasture livestock use was light to moderate in the valley bottom and slight on the side hills at the end of the grazing season. Actual livestock use within the Sario Well pasture was 401 AUMs.</p> <p>In the JW Ranch pasture use was light in the main valley bottom near the key area. Moderate to heavy use at Presto Spring and Big Meadow. Water was hauled to five locations in the Buckskins to redistribute livestock use and use was slight in the canyons. Use within the Sunrise burn varied from slight to moderate. The sunrise meadows were lightly used. Actual livestock use within the JW ranch pasture was: 1) 240 AUMs Buckskins; 2) 163 AUMs Sunrise Burn; 3) 182 AUMs Como Burn; 4) 77 AUMs Big Meadow; and 5) 40 AUMs Upper Spring Gulch. The rest rotation management system began for the pasture.</p> <p>Water was hauled to one location in the Como Canyon to redistribute livestock use. Actual livestock use within the Como pasture was 146 AUMs.</p>	<p>Sario Well +</p> <p>JW Ranch +/-</p> <p>Como No Data</p>

Grazing Year Allotment Actual Use Precipitation	Description of Grazing Use and Forage Conditions	Utilization Levels
2004-2005 1261 AUMs Precipitation -	<p>Data for the 2004 growing season indicated below average precipitation. During the grazing season water was hauled up two side canyons in the Sario Well Pasture to distribute livestock use. Actual livestock use within the pasture was 617 AUMs for the 2004-2005 grazing season.</p> <p>In the JW Ranch pasture use was slight to light in the main canyon along the Churchill Canyon road and in the side canyons in the Buckskin range. There was no use on the side hills. Actual livestock use within the JW ranch pasture was: 1) 197 AUMs Buckskins; 2) 183 AUMs Sunrise Burn; 3) 54 AUMs Como Burn; and 4) 80 AUMs Big Meadow.</p> <p>Water was hauled to one location in the Como Canyon to redistribute livestock use. Actual livestock use within the Como pasture was 136 AUMs.</p>	Sario Well No Data JW Ranch + Como No Data
2005-2006 1663 AUMs Precipitation +	<p>Data for the 2005 growing season indicate above average precipitation during the growing season at three weather stations and below average moisture at two stations. Above average amounts of snow were received in the allotment during January of 2005. In the Sario Well pasture livestock use was light to moderate in the valley bottom and slight on the side hills at the end of the grazing season. Actual livestock use at the end of the grazing season was 637 AUMs.</p> <p>In the JW ranch pasture use was moderate to severe on the north end of the Buckskin range and slight to light on the south end of the range. Water was hauled to five locations in the Buckskins to redistribute livestock use. Use was light in the Big Meadow and the Sunrise meadows. Use was slight to light within the Sunrise Burn. Actual livestock use within the JW ranch pasture was: 1) 353 AUMs Buckskins; 2) 202 AUMs Sunrise Burn; 3) 274 AUMs Como Burn; 4) 78 AUMs Big Meadow; and 5) 5 AUMs Upper Spring Gulch.</p> <p>Use was slight to light along the main road. Water was hauled to one location in the Como Canyon to redistribute livestock use. Actual livestock use within the Como pasture was 156 AUMs.</p>	Sario Well + JW Ranch - Como +

